

# CA/CAT EN 733 ~ 2900 r.p.m.

# CAX EN 733 ~ 2900 r.p.m.

# 4CA/4CAT EN 733 ~ 1450 r.p.m.

# 4CAX EN 733 ~ 1450 r.p.m.



CA/CAT  
4CA/4CAT



CAX  
4CAX

Pompe centrifughe ad asse libero costruite secondo le norme EN 733; trovano vasto utilizzo nell'alimentazione idrica, negli impianti di pressurizzazione e antincendio; come standard vengono fornite di controflangia.

Bare shaft centrifugal pumps constructed in compliance with EN 733 standards; widely used in water supplies, pressurisation and fire-fighting systems. The pump is supplied with counter-flanges.

Bombas centrífugas de eje libre fabricadas según las normas EN 733; se utilizan en gran parte en la alimentación hídrica, en las instalaciones de presurización y antiincendio; según el estándar se suministran con contrabrida.

Pompes centrifuges à axe libre, fabriquées conformément aux normes EN 733. Elles trouvent une ample utilisation dans l'alimentation d'eau, dans les installations de pressurisation et anti-incendie; fournies de série avec contre-bride.

## CARATTERISTICHE COSTRUTTIVE / CONSTRUCTION FEATURES CARACTERÍSTICAS CONSTRUCTIVAS / CARACTÉRISTIQUES D'EXÉCUTION

<b>Corpo pompa</b>	ghisa (CA/CAT) - acciaio inossidabile AISI 316 (CAX)
<b>Pump body</b>	cast iron (CA/CAT) - stainless steel AISI 316 (CAX)
<b>Cuerpo bomba</b>	fundición (CA/CAT) - acero inoxidable AISI 316 (CAX)
<b>Corps de pompe</b>	fonte (CA/CAT) - acier inox AISI 316 (CAX)
<b>Supporto motore</b>	ghisa
<b>Motor bracket</b>	cast iron
<b>Soporte motor</b>	fundición
<b>Support moteur</b>	fonte
<b>Girante</b>	ghisa, bronzo, acciaio (CA/CAT) acciaio inossidabile AISI 316 (CAX)
<b>Impeller</b>	cast iron, bronze, steel (CA/CAT) stainless steel AISI 316 (CAX)
<b>Rodete</b>	fundición, bronce, acero (CA/CAT) acero inoxidable AISI 316 (CAX)
<b>Turbine</b>	fonte, bronzo, acier (CA/CAT) acier inox AISI 316 (CAX)
<b>Tenuta</b>	meccanica ceramica-grafite (CA/CAX) o a baderna cotone impregnato grafite (CAT)
<b>Seal</b>	mechanical ceramic-graphite (CA/CAX) or gland packing graphite impregnated (CAT)
<b>Sello</b>	mecánico cerámica-grafito (CA/CAX) o a trenza algodón impregnado de grafito (CAT)
<b>Garniture</b>	mécanique céramique-graphite (CA/CAX) ou à baderne coton imprégné graphite (CAT)
<b>Sporgenza albero motore</b>	acciaio AISI 316
<b>Pump shaft end</b>	stainless steel AISI 316
<b>Bomba eje</b>	acero AISI 316
<b>Pompe arbre</b>	acier AISI 316
<b>Temperatura del liquido</b>	
<b>Liquid temperature</b>	
<b>Temperatura del liquido</b>	-10 ÷ +90 °C
<b>Température du liquide</b>	
<b>Pressione di esercizio</b>	
<b>Operating pressure</b>	max 10 bar
<b>Presión de trabajo</b>	max 14 bar (... -315 ~ 2900 r.p.m.)
<b>Pression de fonctionnement</b>	
<b>MOTORE / MOTOR / MOTOR / MOTEUR</b>	
<b>Disponibile con motore classe di efficienza IE3</b>	
<b>Available with IE3 efficiency class motor</b>	
<b>Disponibile con motor classe IE3</b>	
<b>Disponible avec moteur classe IE3</b>	

**CA/CAT - CAX EN 733 ~ 2900 r.p.m.**  
**4CA/4CAT - 4CAX EN 733 ~ 1450 r.p.m.**

**VARIANTI COSTRUTTIVE /VERSIONS**  
**VARIABLES COSTRUTTIVAS / VARIANTES DE CONSTRUCCIONES**

Pump model code

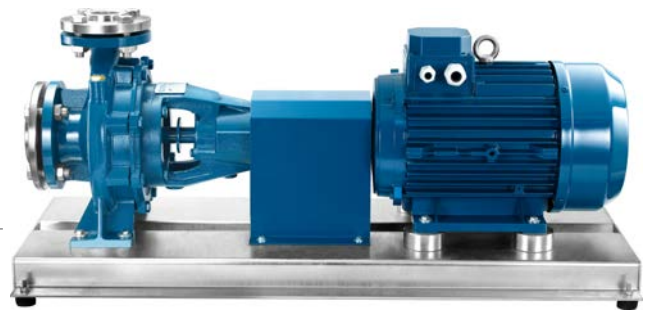
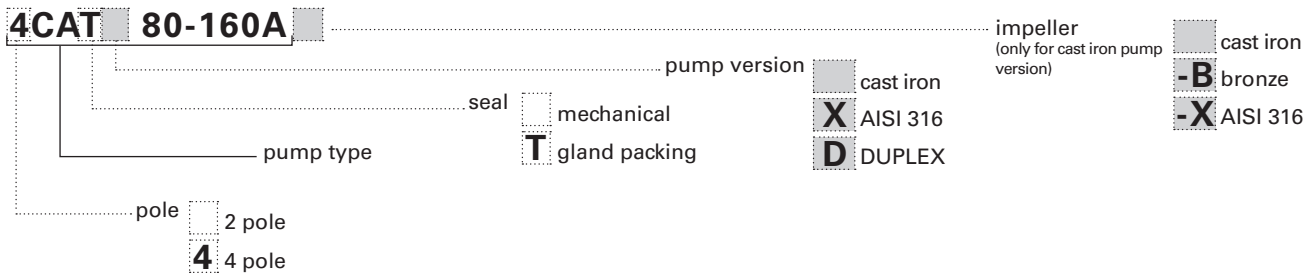

CA/CAT  
4CA/4CAT

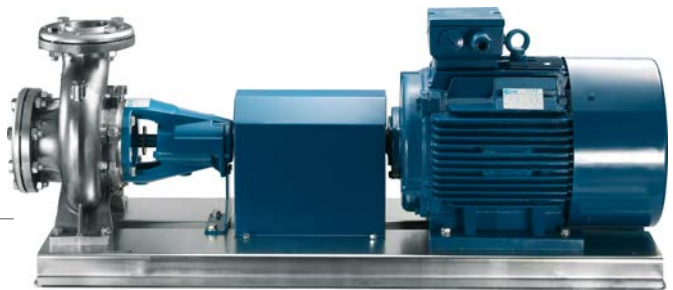

CAX  
4CAX

**CA/CAX**  
**4CA/4CAX**  
 tenuta meccanica  
 mechanical seal  
 sello mecánico  
 garniture mécanique



**CAT**  
**4CAT**  
 tenuta a baderna  
 gland packing seal  
 sello a trenza algodón  
 garniture à baderne





# CA/CAT - CAX EN 733 ~ 2900 r.p.m.

TYPE	P <sub>2</sub> nom. kW	Motor Size	Q (m³/h - l/min)																	
			0	42	45	48	54	60	66	72	78	84	96	108	120	132	138	144		
			0	700	750	800	900	1000	1100	1200	1300	1400	1600	1800	2000	2200	2300	2400		
			H (m) / pump input power (kW)																	
50-315DN No EN 733; only CA version	37	200L	87,8 11,19	90,4 20,11	90,3 20,81	90,2 21,52	89,9 22,91	89,2 24,19	88,2 25,41	87,1 26,58	86,0 27,71	84,8 28,81	82,4 30,91	79,9 32,92	76,9 34,81	73,4 36,56				
50-315CN No EN 733; only CA version	45	225M	101,8 13,32	105,0 23,97	104,9 24,79	104,8 25,63	104,3 27,25	103,7 28,77	102,7 30,21	101,5 31,55	100,3 32,85	99,1 34,15	96,7 36,68	94,1 39,06	91,3 41,26	88,7 43,26				
50-315BN No EN 733; only CA version	55	250M	122,3 17,44	124,3 29,30	124,4 30,29	124,5 31,30	124,7 33,28	124,4 35,10	123,6 36,80	122,5 38,35	121,3 39,85	119,9 41,39	116,6 44,41	113,3 47,32	110,1 50,01	107,1 52,39	105,4 53,60	103,5 54,83		
50-315AN No EN 733; only CA version	75	280S	146,1 22,75	146,9 35,89	147,1 37,03	147,3 38,21	147,4 40,53	147,3 42,66	146,9 44,71	146,3 46,72	145,3 48,67	144,1 50,59	141,2 54,26	137,9 57,67	134,1 60,84	130,0 63,78	127,9 65,11	125,8 66,34		

TYPE	P <sub>2</sub> nom. kW	Motor Size	Q (m³/h - l/min)																				
			0	30	33	36	39	42	45	48	54	60	66	72	78	84	96	108	120	132	138	144	150
			0	500	550	600	650	700	750	800	900	1000	1100	1200	1300	1400	1600	1800	2000	2200	2300	2400	2500
			H (m) / pump input power (kW)																				
65-125B	5,5	132S	19,7 2,07	20,6 3,36	20,5 3,49	20,4 3,62	20,4 3,75	20,3 3,87	20,2 3,99	20,2 4,11	20,0 4,34	19,7 4,54	19,3 4,71	18,8 4,87	18,2 5,03	17,5 5,17	16,3 5,45	15,0 5,67	13,1 5,84				
65-125A	7,5	132S	24,6 2,95	25,2 4,37	25,2 4,52	25,1 4,68	25,1 4,83	25,0 4,98	24,9 5,13	24,9 5,29	24,7 5,60	24,5 5,89	24,2 6,16	23,9 6,41	23,5 6,65	23,0 6,86	22,0 7,25	20,6 7,55	18,8 7,77	16,8 7,93			
65-160C	11	160M	28,9 2,67					30,6 5,52	30,5 5,71	30,3 5,90	30,0 6,26	29,6 6,60	29,1 6,93	28,5 7,23	27,9 7,51	27,2 7,77	25,3 8,26	22,9 8,64	20,2 8,92	17,5 9,11	16,0 9,17	13,9 9,19	
65-160B	11	160M	33,2 3,37					35,1 6,51	35,0 6,74	34,9 6,95	34,6 7,37	34,3 7,77	33,8 8,17	33,3 8,56	32,8 8,91	32,1 9,24	30,4 9,85	28,2 10,38	25,5 10,82	22,5 11,17	21,4 11,34	20,4 11,49	
65-160A	15	160M	40,1 4,54					42,5 8,31	42,5 8,59	42,5 8,86	42,3 9,37	42,1 9,86	41,8 10,35	41,4 10,85	41,0 11,32	40,4 11,77	38,9 12,65	37,1 13,46	35,3 14,14	32,8 14,79	31,7 15,14	30,9 15,52	
65-200C	15	160M	44,4 4,38								46,1 10,30	45,4 10,87	44,7 11,44	44,0 12,00	43,2 12,52	42,4 12,98	40,3 13,76	37,5 14,36	33,7 14,89	28,9 15,27	26,8 15,43		
65-200B	18,5	160L	51,7 5,71								53,9 12,58	53,4 13,25	52,7 13,89	52,0 14,51	51,3 15,12	50,4 15,66	48,6 16,56	45,9 17,56	43,0 18,37	39,4 18,96	37,1 19,20	34,6 19,42	
65-200A	22,5	180M	60,3 7,25								61,8 14,56	61,4 15,38	61,0 16,18	60,4 16,93	59,8 17,64	59,1 18,33	57,1 19,66	54,6 20,84	51,6 21,83	48,3 22,73	46,5 23,10	44,4 23,41	
65-250B	30	200L	80,6 9,16								80,6 19,79	79,5 20,77	78,4 21,74	77,1 22,72	75,7 23,63	74,1 24,37	70,4 25,59	66,1 26,73	61,0 27,55	54,7 28,09	51,0 28,27	47,3 28,38	
65-250A	37	200L	91,6 11,32								91,6 23,01	90,8 24,18	89,8 25,33	88,6 26,47	87,4 27,58	85,9 28,55	82,5 30,14	77,8 31,64	72,8 32,77	67,4 33,54	64,3 33,85	60,8 34,09	57,9 34,25

TYPE	P <sub>2</sub> nom. kW	Motor Size	Q (m³/h - l/min)																				
			0	54	60	66	72	78	84	96	108	120	132	138	144	150	156	168	180	195	210		
			0	900	1000	1100	1200	1300	1400	1600	1800	2000	2200	2300	2400	2500	2600	2800	3000	3250	3500		
			H (m) / pump input power (kW)																				
65-315CN only CA version	55	250M	93,9 15,58	96,5 26,64	96,4 27,96	96,3 29,26	96,0 30,48	95,6 31,67	95,1 32,88	93,8 35,28	92,3 37,55	90,7 39,76	89,1 41,99	88,3 43,09	87,5 44,18	86,5 45,24	85,5 46,28	83,2 48,31	80,8 50,27				
65-315BN only CA version	75	280S	116,5 21,16	117,9 34,28	117,8 35,82	117,7 37,35	117,4 38,80	116,4 40,26	116,4 41,84	114,9 45,05	113,3 47,88	111,4 50,51	109,4 53,05	108,3 54,27	107,2 55,48	106,0 56,64	104,9 57,76	102,5 59,94	99,9 62,26	96,3 65,43			
65-315AN only CA version	90	280M	138,2 26,69	138,8 43,17	138,5 45,02	138,1 46,88	137,6 48,78	137,0 50,67	136,4 52,51	135,0 56,09	133,5 59,51	131,7 62,82	129,5 66,08	128,3 67,67	127,0 69,20	125,8 70,68	124,5 72,10	121,8 74,81	118,8 77,32	114,8 80,16	110,4 83,11		



# CA/CAT - CAX EN 733 ~ 2900 r.p.m.

TYPE	P <sub>2</sub> nom. kW	Motor Size	Q (m <sup>3</sup> /h - l/min)																	
			0	66	72	78	84	96	108	120	132	138	144	156	168	180	195	210	225	240
			0	1100	1200	1300	1400	1600	1800	2000	2200	2300	2400	2600	2800	3000	3250	3500	3750	4000
			H (m) / pump input power (kW)																	
80-160E	11	160M	21,5 3,48	22,9 6,43	22,5 6,65	22,1 6,86	21,6 7,07	20,8 7,45	19,9 7,76	18,9 8,05	17,7 8,38	17,2 8,52	16,6 8,65	15,3 8,84	13,7 8,88					
80-160D	11	160M	25,4 4,16	27,3 7,74	27,0 8,01	26,6 8,27	26,3 8,53	25,4 9,03	24,5 9,46	23,5 9,79	22,4 10,14	21,8 10,32	21,2 10,49	19,9 10,76	18,3 10,95	16,4 11,07				
80-160C	15	160M	29,0 4,74	30,9 8,66	30,7 8,98	30,4 9,29	30,1 9,59	29,4 10,22	28,5 10,85	27,4 11,38	26,3 11,85	25,8 12,06	25,3 12,25	24,1 12,59	22,5 12,85	20,7 13,05	18,4 13,21			
80-160B	18,5	160L	33,6 6,28	35,9 10,61	35,7 10,94	35,4 11,25	35,2 11,57	34,5 12,25	33,7 12,99	32,9 13,69	32,0 14,33	31,6 14,62	31,1 14,90	30,0 15,38	28,6 15,75	27,0 16,04	24,5 16,35	22,0 16,57		
80-160A	22,5	180M	38,0 6,82	40,5 12,04	40,4 12,50	40,2 12,96	40,1 13,42	39,6 14,34	39,1 15,23	38,4 16,05	37,5 16,81	37,1 17,19	36,6 17,57	35,4 18,29	34,1 18,86	32,6 19,34	30,4 19,84	28,3 20,38	23,9 20,28	
80-200B	30	200L	50,4 8,89				54,5 18,00	53,9 19,22	53,2 20,56	52,3 22,05	51,3 23,32	50,7 23,79	50,2 24,21	48,9 25,06	47,4 26,03	45,8 26,97	43,4 27,97	40,9 28,81	38,5 29,48	
80-200A	37	200L	57,3 10,32				61,7 21,15	61,3 22,80	60,6 24,43	59,4 26,13	58,2 27,62	57,8 28,17	57,5 28,57	56,8 29,28	55,4 30,39	53,7 31,67	51,5 32,98	49,1 34,05	46,6 34,94	43,9 35,68
80-250B	45	225M	77,2 14,01				80,0 30,93	79,0 32,60	77,5 34,34	75,3 36,13	74,2 37,02	73,1 37,86	71,0 39,38	69,0 40,78	67,0 42,10	64,5 43,60	61,8 44,94	58,8 46,15		
80-250A	55	250M	90,0 16,74				92,8 36,56	91,1 38,57	89,3 40,54	87,4 42,46	86,4 43,39	85,4 44,31	83,1 46,12	80,7 47,81	78,5 49,29	75,7 50,92	72,4 52,59	68,8 54,18	65,2 55,50	

TYPE	P <sub>2</sub> nom. kW	Motor Size	Q (m <sup>3</sup> /h - l/min)																	
			0	78	84	96	108	120	132	138	144	156	168	180	195	210	225	240	255	
			0	1300	1400	1600	1800	2000	2200	2300	2400	2600	2800	3000	3250	3500	3750	4000	4250	
			H (m) / pump input power (kW)																	
80-315BN only CA version	90	280M	108,0 21,85	112,4 42,35	112,4 44,06	112,2 47,49	111,7 50,86	111,1 54,13	110,2 57,25	109,7 58,76	109,1 60,24	107,9 63,14	106,4 65,95	104,9 68,72	102,7 72,14	100,4 75,60	98,3 78,97	95,7 82,15	90,8 85,17	
80-315AN only CA version	110	315S	140,5 31,92	141,4 55,48	141,1 57,36	140,2 61,13	139,2 64,91	138,1 68,78	136,9 72,88	136,2 74,96	135,5 76,96	134,1 80,84	132,5 84,36	131,0 87,02	128,7 90,23	125,8 94,76	122,5 99,35	121,7 103,04	118,5 106,15	

TYPE	P <sub>2</sub> nom. kW	Motor Size	Q (m <sup>3</sup> /h - l/min)																	
			0	108	120	132	138	144	156	168	180	195	210	225	240	255	270	300	330	360
			0	1800	2000	2200	2300	2400	2600	2800	3000	3250	3500	3750	4000	4250	4500	5000	5500	6000
			H (m) / pump input power (kW)																	
100-200B	45	225M	56,1 21,75	56,8 28,84	56,5 29,78	56,1 30,74	55,9 31,24	55,6 31,75	55,1 32,81	54,5 33,89	53,9 35,04	53,1 36,50	52,2 37,82	51,4 38,89	50,4 39,85	49,0 40,77	47,5 41,60	43,8 42,92	39,7 43,82	
100-200A	55	250M	61,1 24,57	62,2 33,04	61,8 34,07	61,5 35,11	61,2 35,64	61,0 36,18	60,5 37,28	59,9 38,39	59,5 39,49	58,9 40,86	58,3 42,23	57,4 43,60	56,4 44,97	55,2 46,20	53,8 47,28	50,6 49,05	42,5 51,62	
100-250C	55	250M	71,9		73,2	73,1	73,0	72,9	72,6	72,2	71,8	71,1	70,3	69,3	67,9	66,4	64,7	61,0		
	75	280S	24,75		40,12	41,93	42,84	43,70	45,28	46,77	48,21	49,94	51,65	53,38	55,05	56,66	58,19	60,99		
100-250B	75	280S	83,6 29,69		83,7 47,10	83,5 49,06	83,4 50,04	83,2 51,01	82,9 52,92	82,5 54,76	82,1 56,47	81,4 58,46	80,8 60,26	80,0 61,86	79,0 63,49	77,9 65,17	76,4 66,93	72,0 70,91	67,6 73,78	
100-250A	90	280M	93,5 32,71		93,9 51,99	93,7 54,14	93,5 55,23	93,4 56,31	92,9 58,48	92,4 60,60	91,8 62,57	90,9 64,88	89,9 66,97	88,8 68,84	87,4 70,81	85,7 72,81	84,0 74,73	80,4 78,17	73,2 85,53	



# CA/CAT - CAX EN 733 ~ 2900 r.p.m.

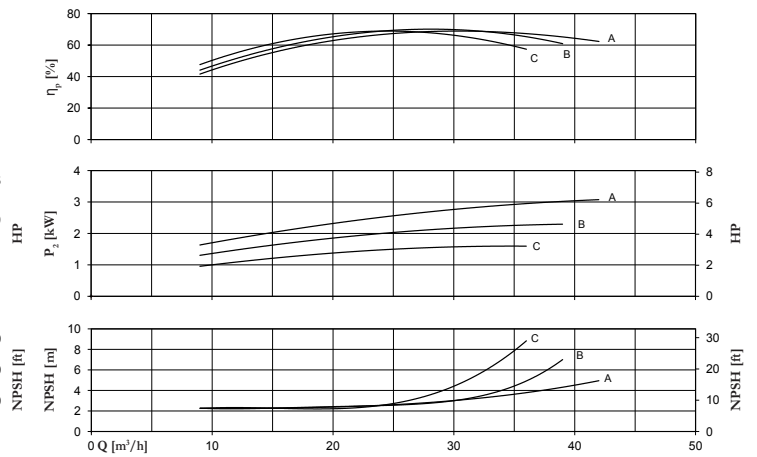
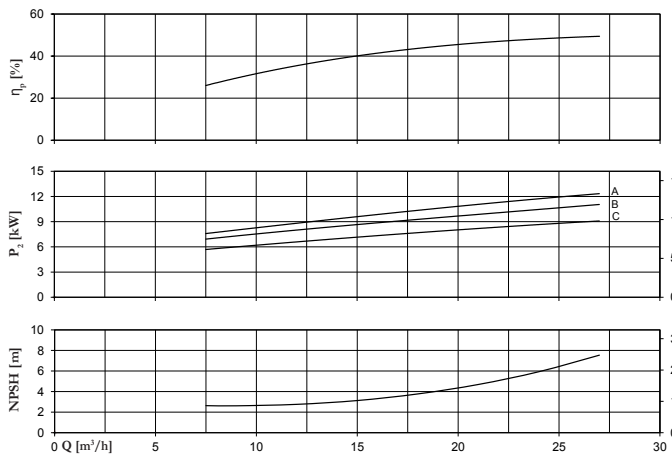
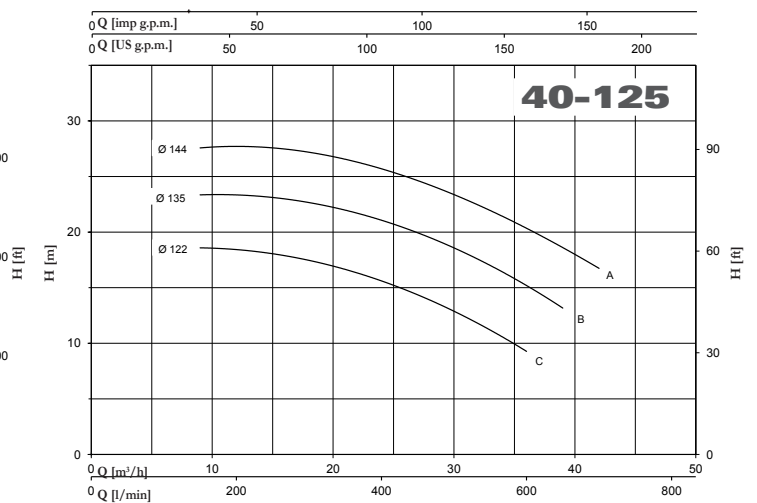
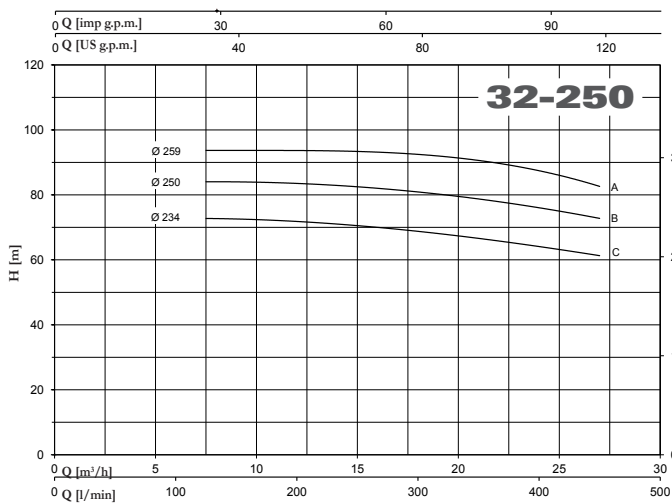
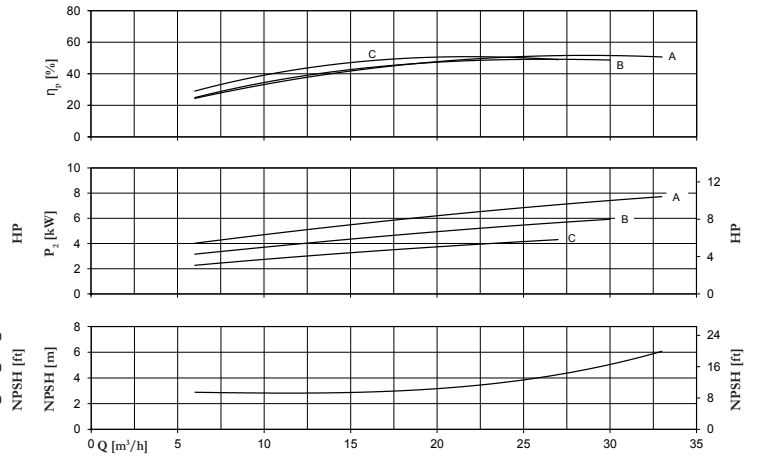
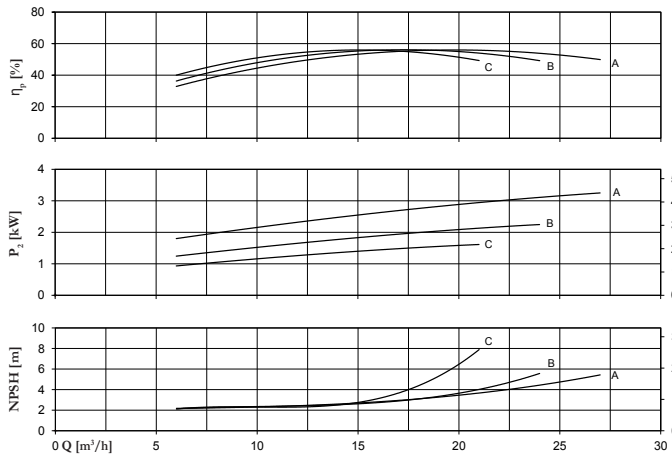
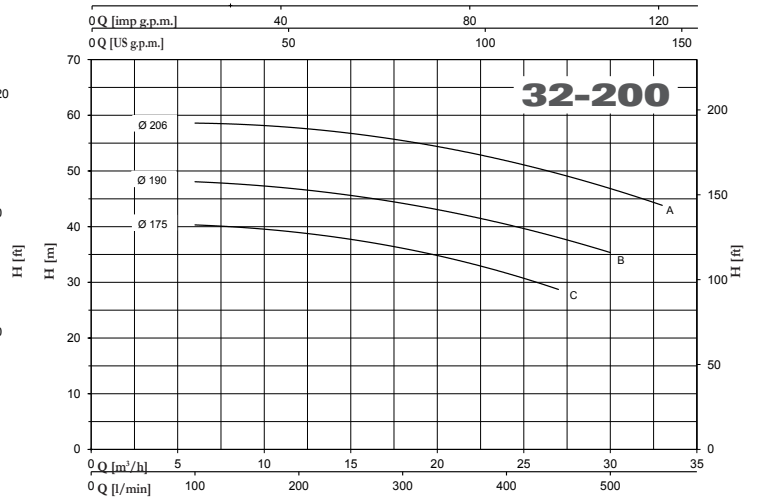
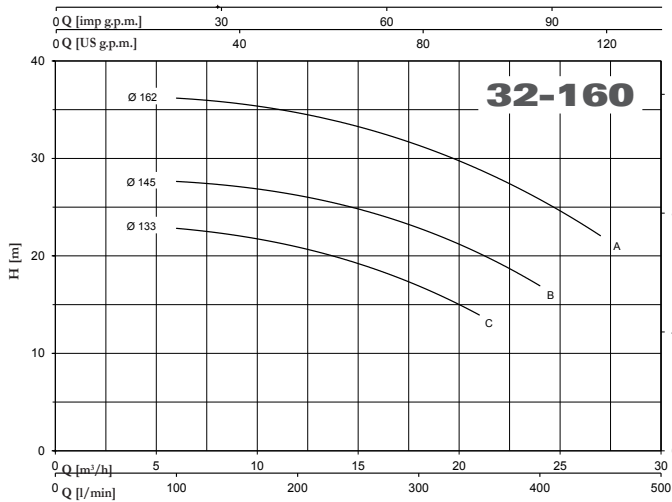

# CA/CAT - CAX EN 733 ~ 2900 r.p.m.

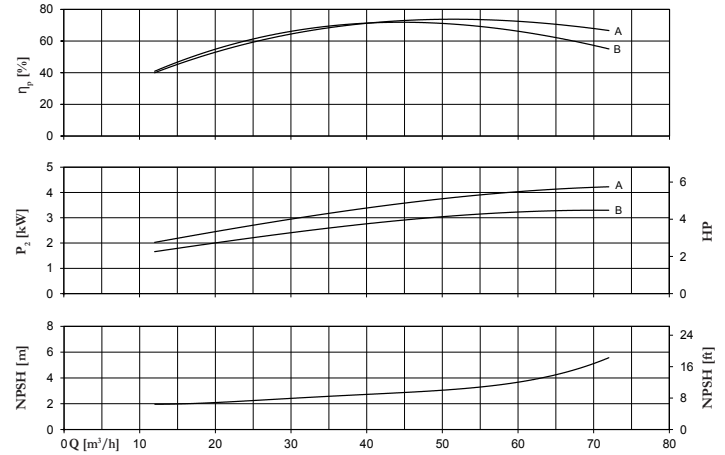
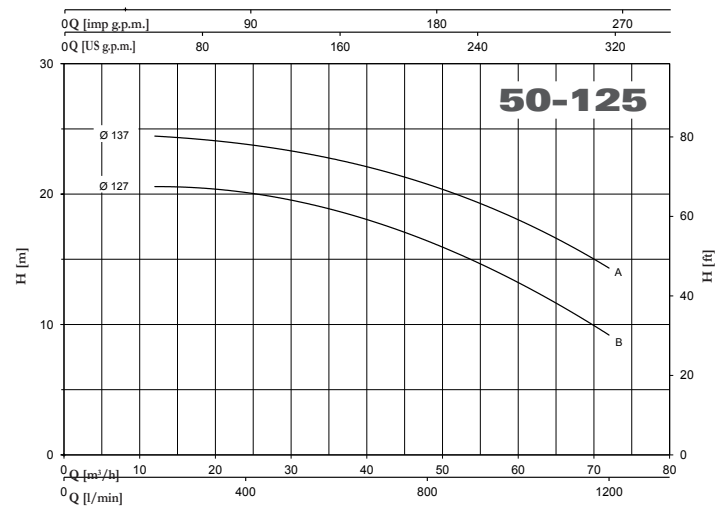
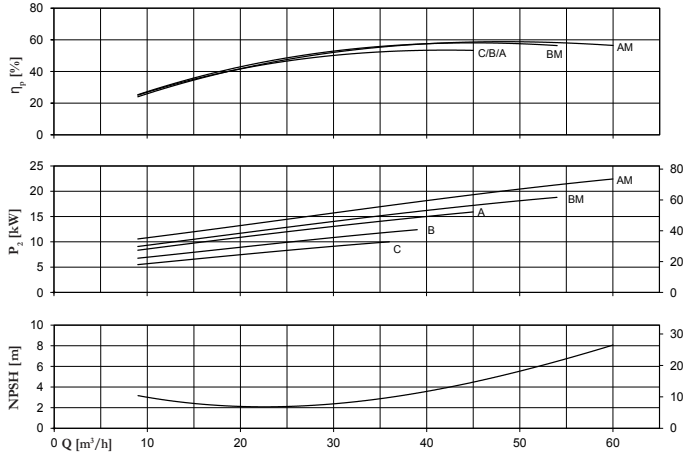
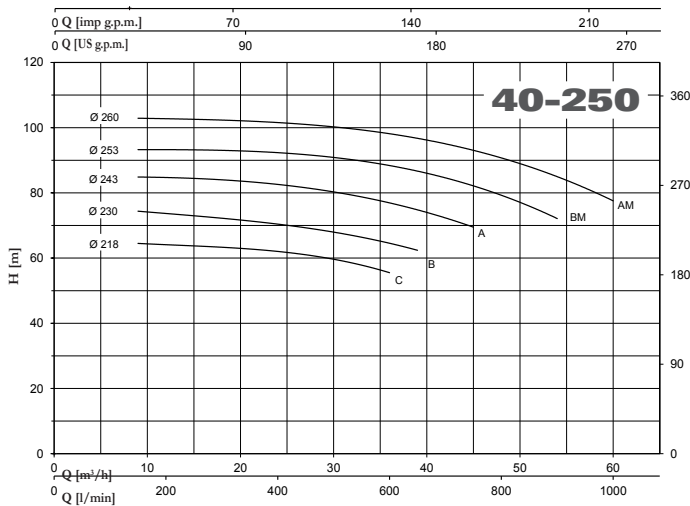
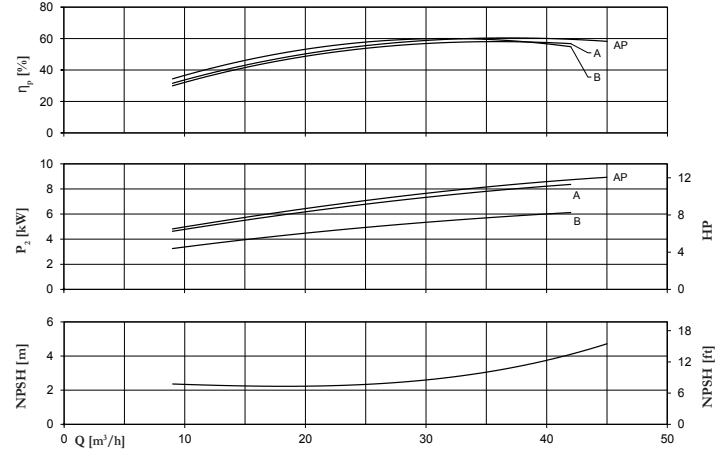
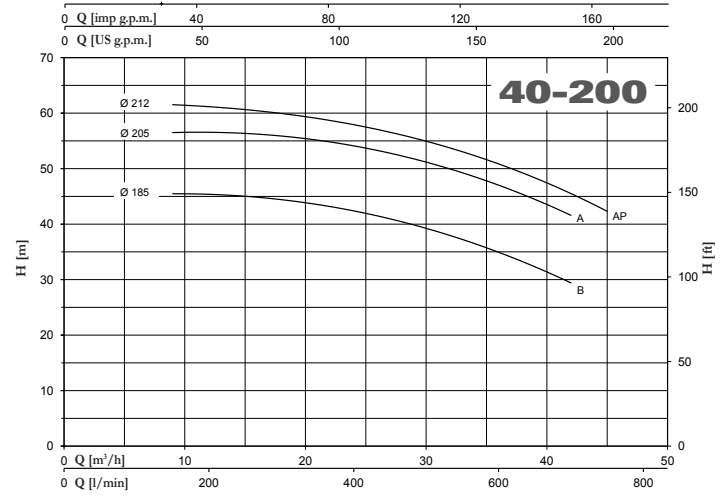
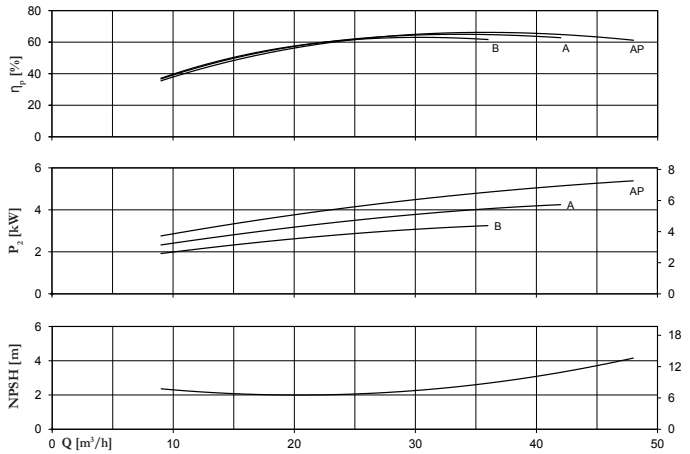
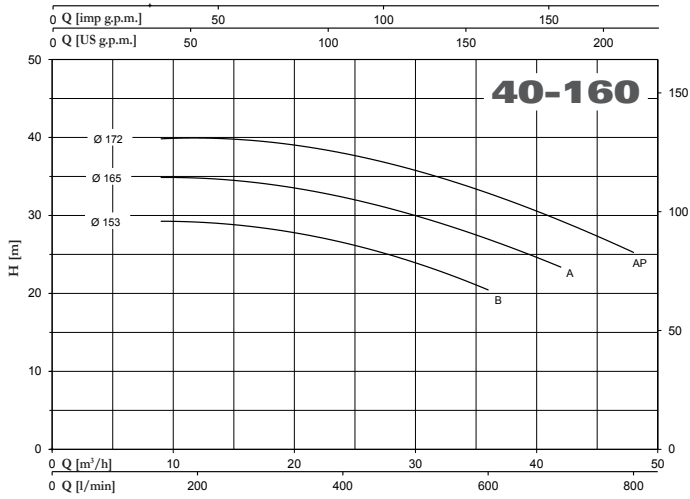

# CA/CAT - CAX EN 733 ~ 2900 r.p.m.

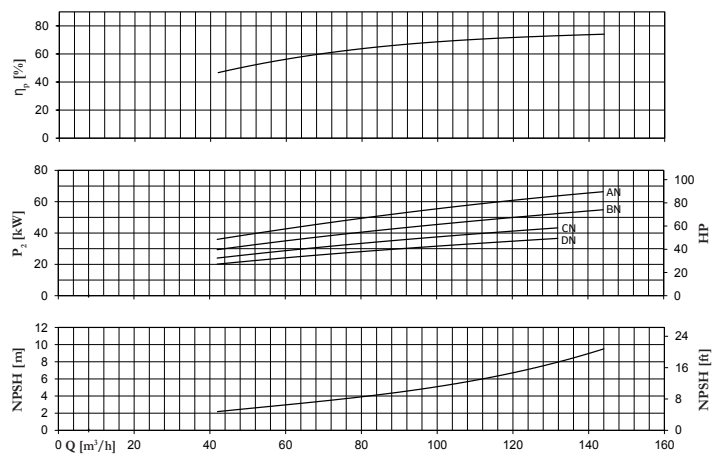
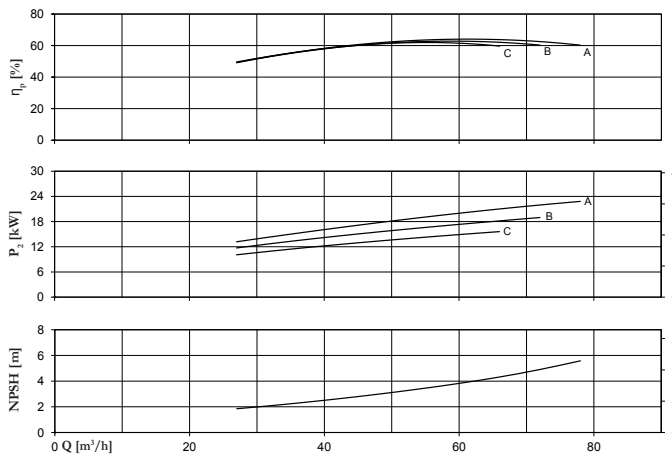
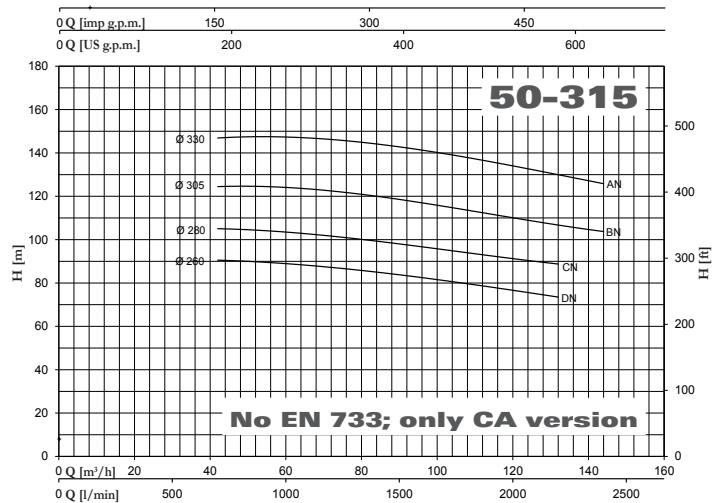
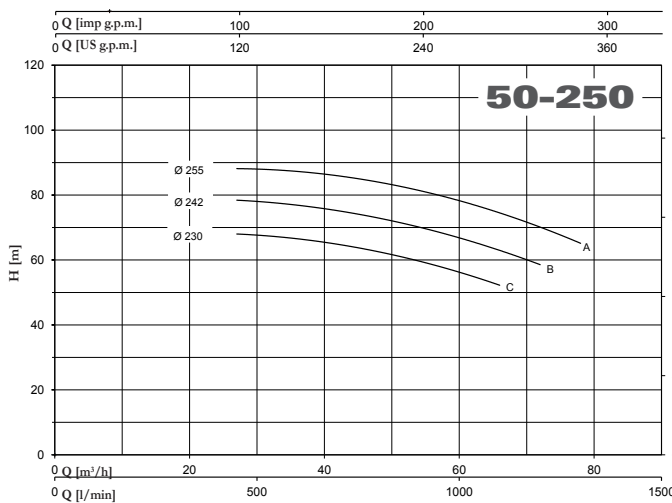
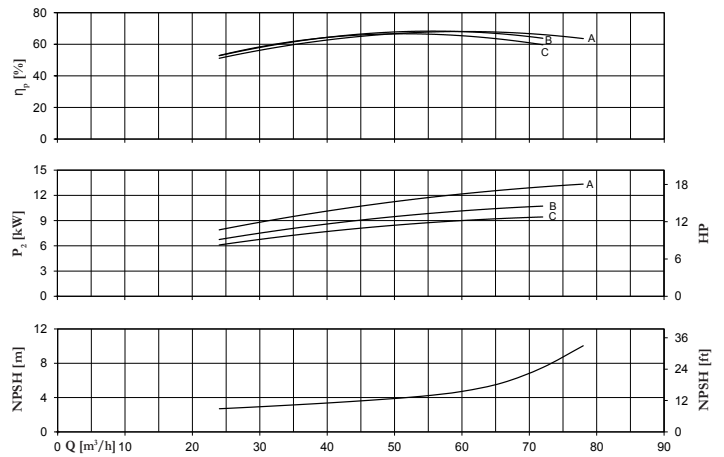
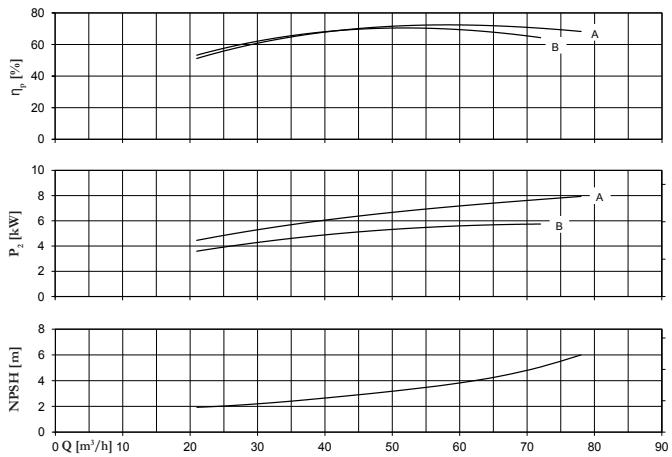
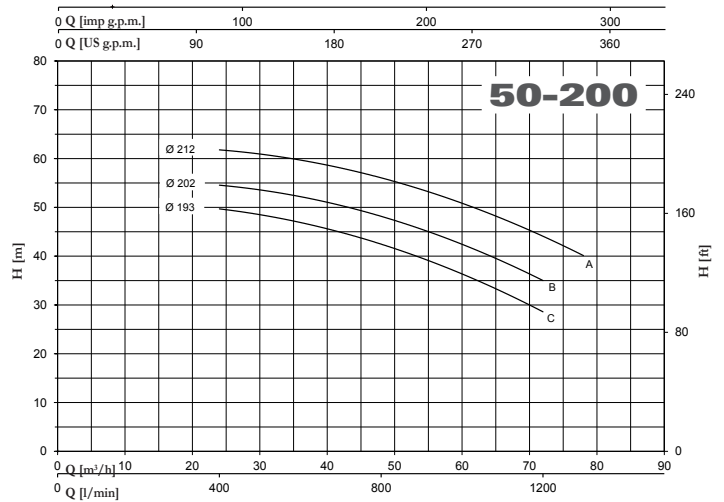
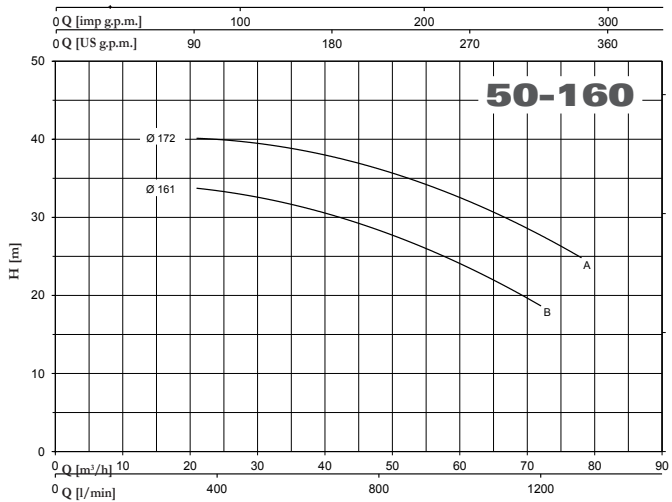

**No EN 733; only CA version**





# CA/CAT - CAX EN 733 ~ 2900 r.p.m.

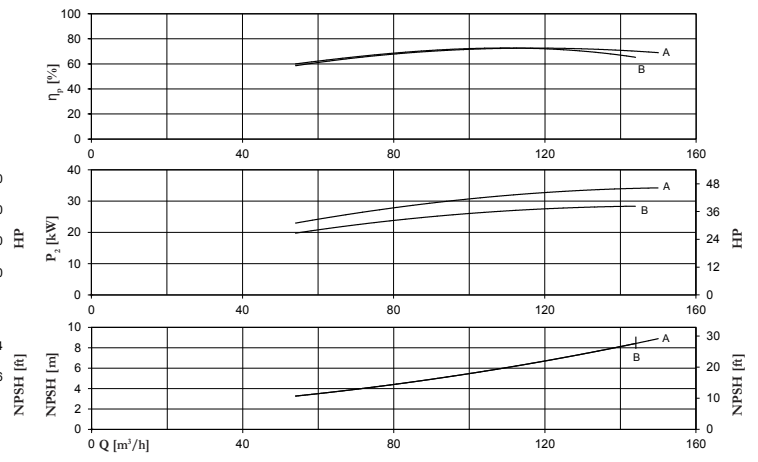
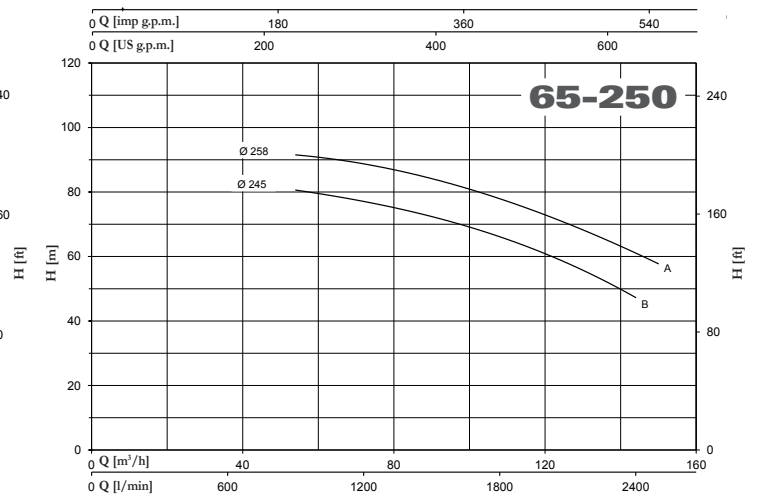
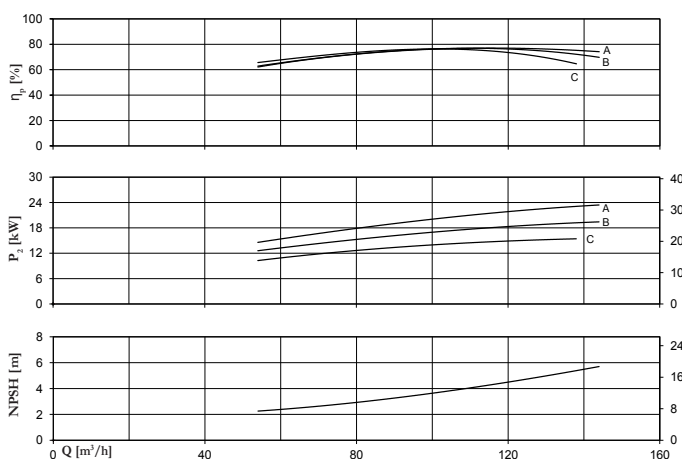
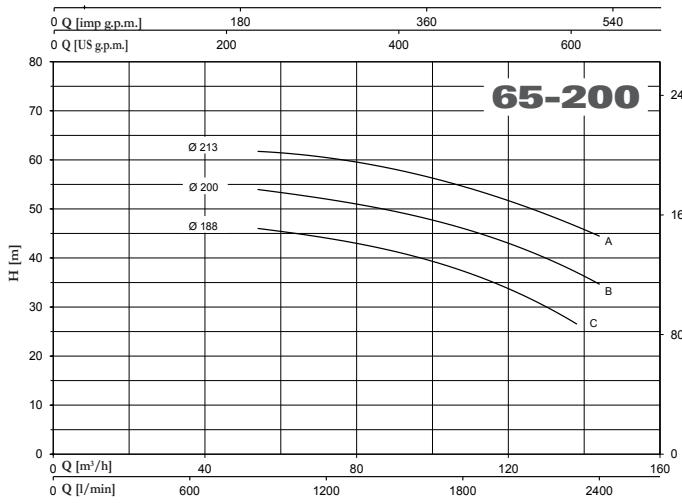
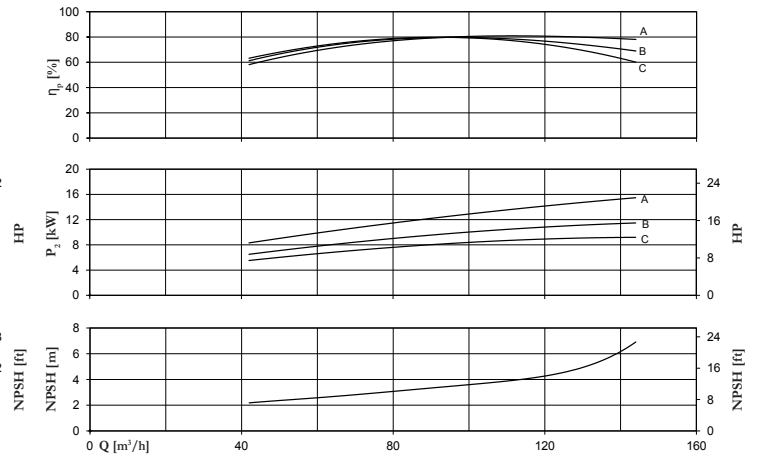
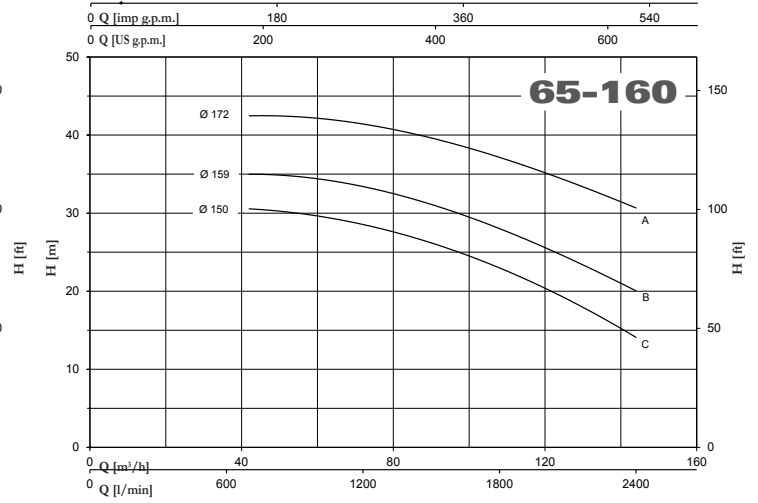
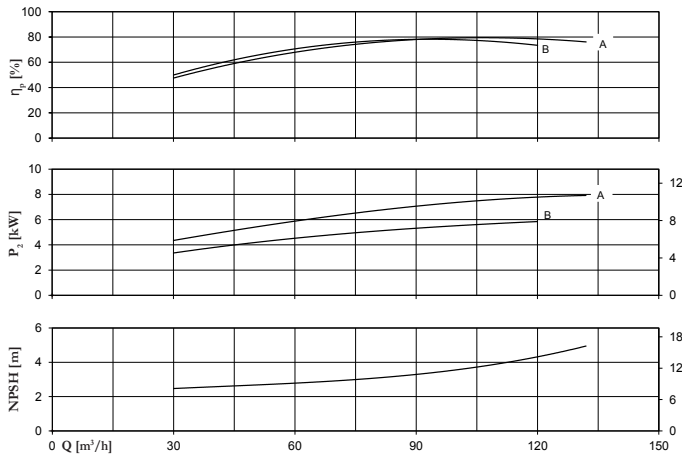
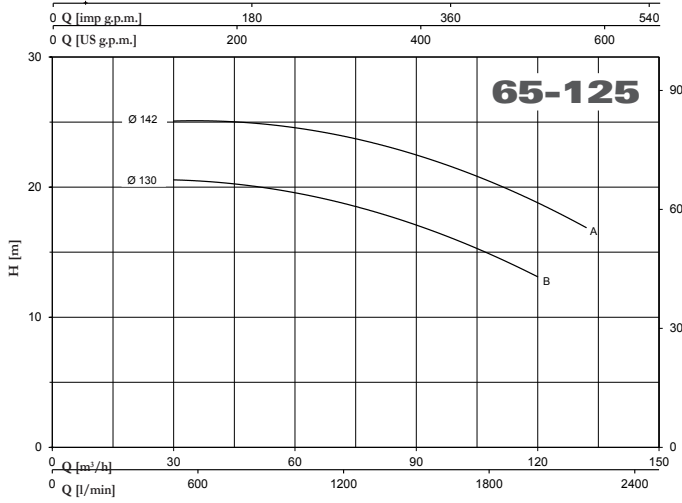

# CA/CAT - CAX EN 733 ~ 2900 r.p.m.

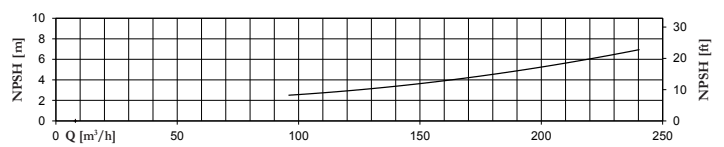
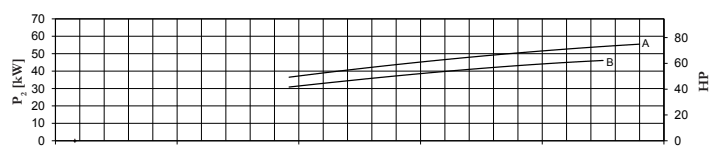
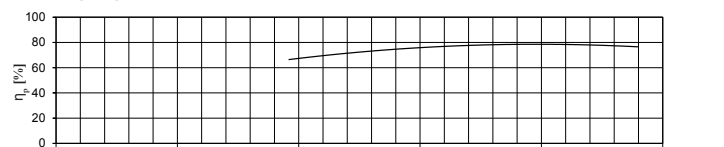
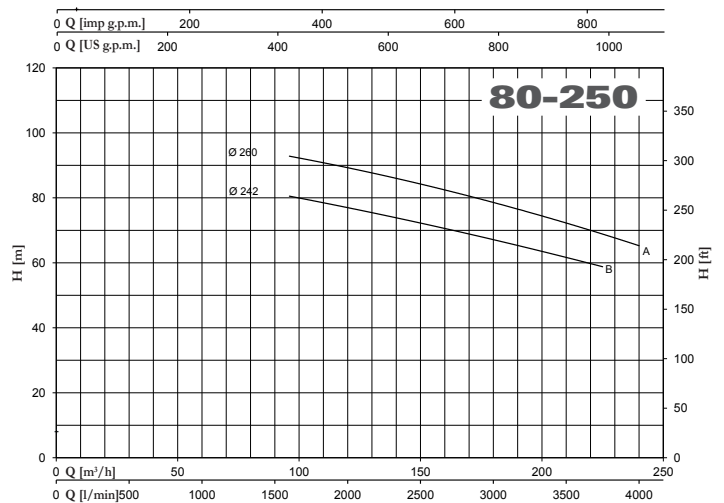
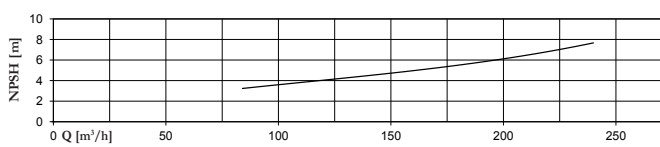
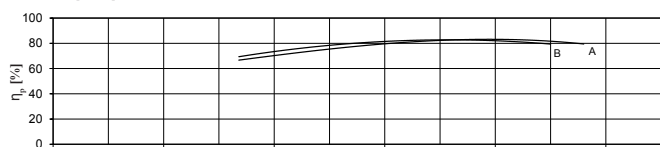
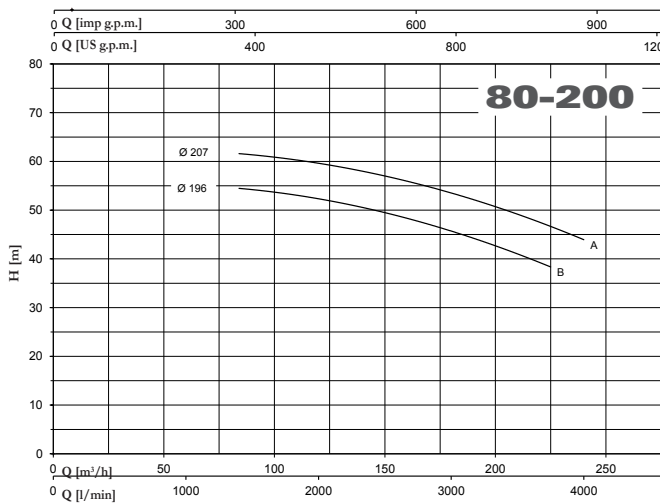
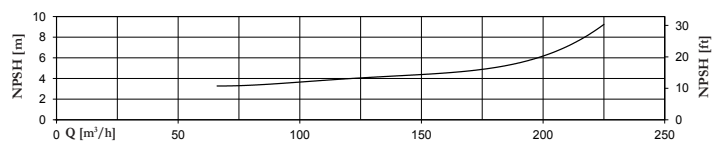
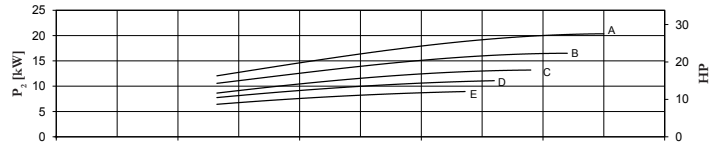
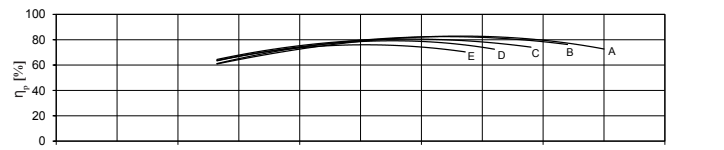
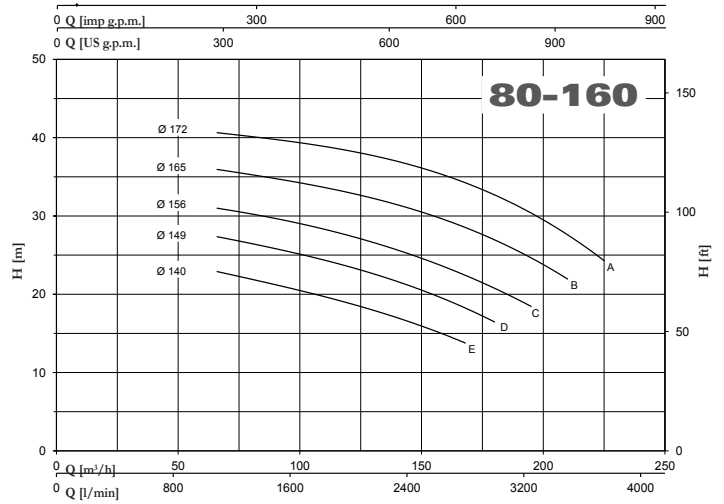
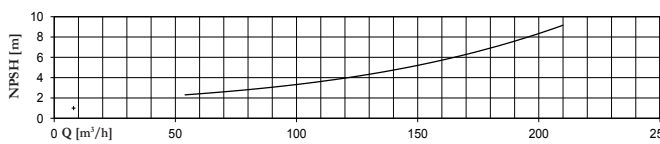
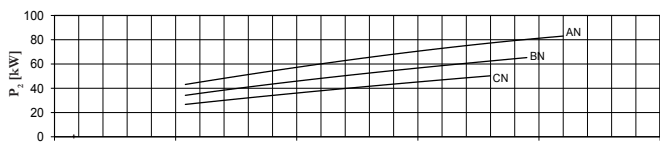
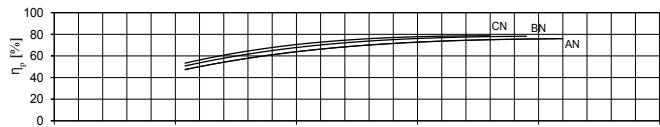
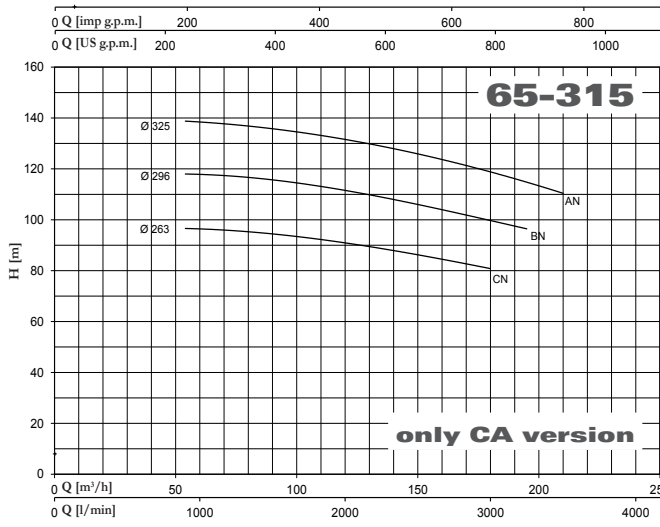

# CA/CAT - CAX EN 733 ~ 2900 r.p.m.

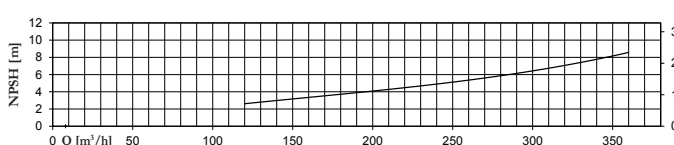
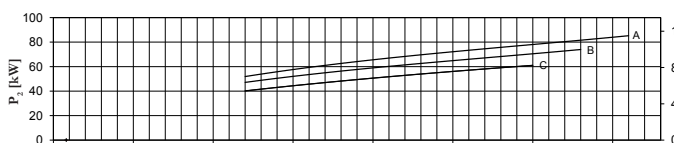
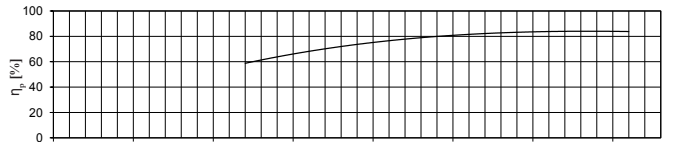
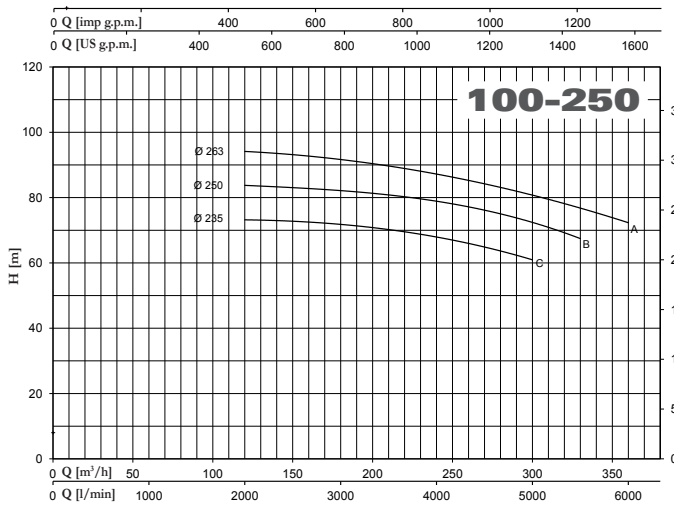
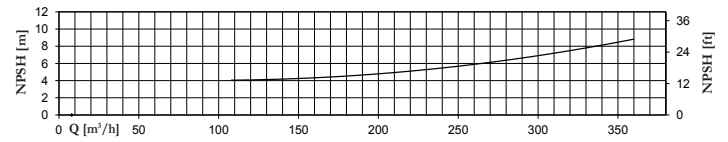
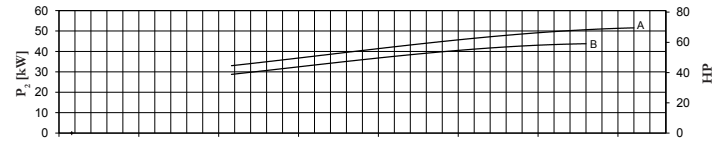
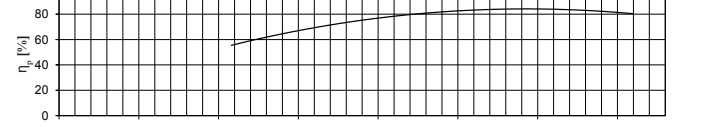
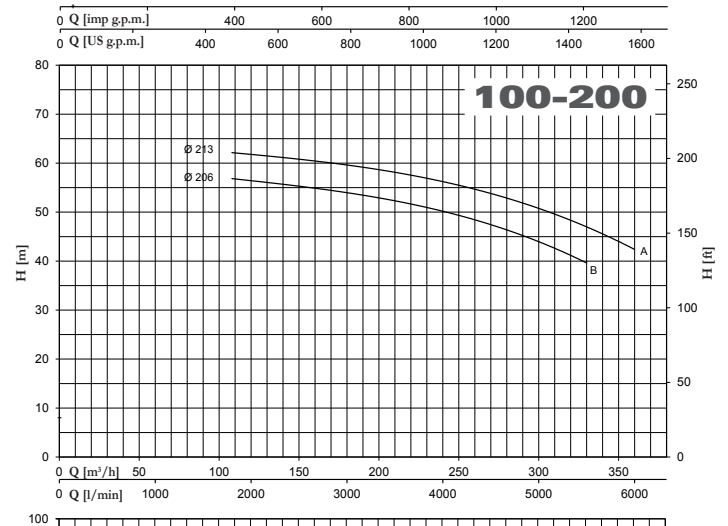
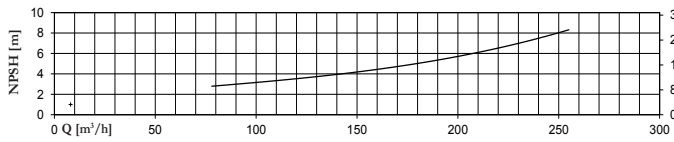
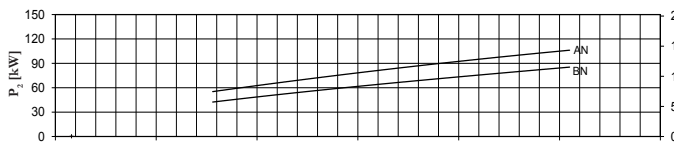
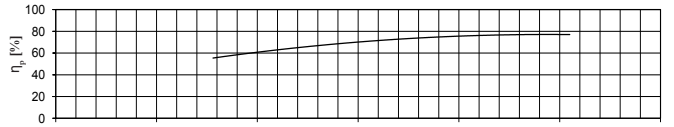
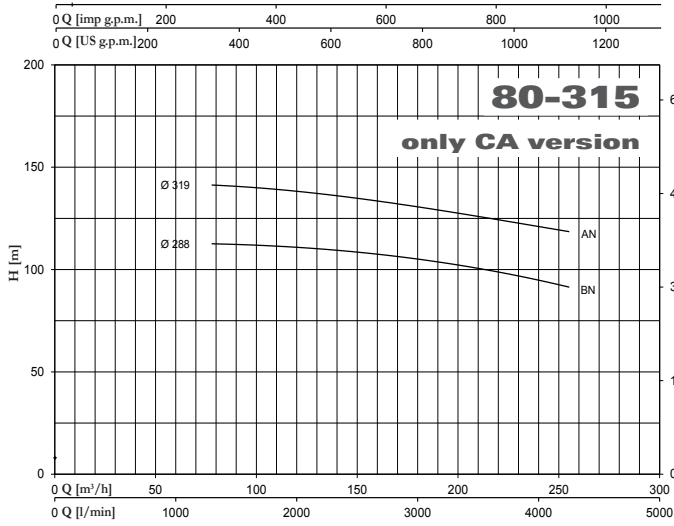



# 4CA/4CAT - 4CAX EN 733 ~ 1450 r.p.m.

TYPE	P <sub>2</sub> nom. kW	Motor Size	Q (m³/h - l/min)												
			0	1,5	3	4,5	6	7,5	9	10,5	12	15	18	21	
			0	25	50	75	100	125	150	175	200	250	300	350	
H (m) / pump input power (kW)															
32-160C	0,37	71M	5,9 0,15	5,9 0,18	5,8 0,20	5,5 0,22	5,3 0,24	4,8 0,26	4,3 0,28	3,5 0,28	2,6 0,29				
32-160B	0,37	71M	7,2 0,18	7,2 0,21	7,1 0,24	6,7 0,27	6,4 0,29	5,9 0,31	5,3 0,33	4,6 0,34	3,6 0,36				
32-160A	0,55	80M	8,8 0,22	8,8 0,26	8,7 0,29	8,5 0,31	8,2 0,35	7,9 0,37	7,4 0,39	6,9 0,41	6,1 0,43	4,0 0,45			
32-200C	0,75	80M	11,0 0,26		10,8 0,39	10,6 0,43	10,2 0,47	9,9 0,51	9,4 0,54	8,9 0,57	8,4 0,59	6,7 0,66	4,2 0,71		
32-200B	1,1	90S	13,0 0,38		12,7 0,47	12,5 0,51	12,2 0,56	11,7 0,61	11,2 0,66	10,6 0,70	10,1 0,74	8,7 0,78	6,3 0,81		
32-200A	1,1	90S	15,9 0,44		15,7 0,53	15,5 0,57	15,3 0,66	15,0 0,71	14,5 0,77	13,8 0,82	13,2 0,88	11,7 0,98	9,5 1,04	6,8 1,10	
32-250C	1,5	90L	17,5 0,55		17,2 0,75	16,9 0,79	16,6 0,85	16,2 0,90	15,7 0,95	15,1 1,00	14,4 1,04	12,5 1,09	10,0 1,18	6,5 1,21	
32-250B	1,5	90L	20,3 0,75		20,0 0,87	19,7 0,93	19,4 1,00	19,0 1,06	18,4 1,14	17,8 1,19	17,0 1,24	15,3 1,33	12,6 1,39	8,3 1,42	
32-250A	2,2	100L	22,6 0,80		22,2 0,95	21,9 1,03	21,6 1,10	21,3 1,18	20,7 1,24	20,0 1,30	18,9 1,36	17,2 1,46	14,8 1,52	9,1 1,55	

TYPE	P <sub>2</sub> nom. kW	Motor Size	Q (m³/h - l/min)														
			0	4,5	6	7,5	9	10,5	12	15	18	21	24	27	30	33	
			0	75	100	125	150	175	200	250	300	350	400	450	500	550	
H (m) / pump input power (kW)																	
40-125C	0,37	71M	4,2 0,15	4,4 0,18	4,3 0,19	4,2 0,21	4,1 0,23	4,0 0,23	3,8 0,25	3,4 0,26	2,8 0,27	2,0 0,29					
40-125B	0,37	71M	5,4 0,19	5,5 0,22	5,5 0,25	5,4 0,26	5,3 0,28	5,2 0,29	5,0 0,31	4,6 0,34	4,0 0,35	3,3 0,37					
40-125A	0,55	80M	6,2 0,23	6,3 0,28	6,3 0,30	6,2 0,32	6,1 0,34	6,0 0,36	5,8 0,38	5,4 0,40	4,9 0,43	4,2 0,44	3,4 0,46				
40-160B	0,55	80M	7,4 0,21	7,5 0,29	7,6 0,34	7,4 0,37	7,2 0,40	7,0 0,42	6,8 0,43	6,1 0,45	4,9 0,47	3,7 0,48	2,5 0,47				
40-160A	0,75	80M	8,8 0,23	8,9 0,34	9,0 0,38	8,9 0,41	8,7 0,45	8,5 0,47	8,3 0,49	7,5 0,53	6,6 0,57	5,6 0,59	4,5 0,60				
40-160AP	0,75 1,1	80M 90S	11,1 0,32	11,1 0,47	11,3 0,52	11,3 0,56	11,1 0,60	10,9 0,64	10,6 0,67	10,0 0,72	9,0 0,77	8,0 0,81	6,8 0,84				
40-200B	1,1	90S	11,3 0,36		11,4 0,52	11,3 0,56	11,1 0,60	10,8 0,64	10,5 0,68	9,6 0,75	8,5 0,78	6,9 0,81	4,7 0,84				
40-200A	1,1	90S	13,8 0,37		13,9 0,64	13,8 0,72	13,6 0,74	13,4 0,79	13,2 0,82	12,3 0,91	11,3 0,99	10,0 1,06	8,3 1,13				
40-200AP	1,1 1,5	90S 90L	14,8 0,41		14,9 0,69	14,8 0,79	14,6 0,81	14,4 0,86	14,2 0,90	13,3 0,99	12,3 1,08	11,0 1,16	9,4 1,23				
40-250C	1,5	90L	15,7 0,61				15,2 0,93	15,0 0,98	14,7 1,04	14,0 1,14	12,8 1,22	11,1 1,32	9,1 1,38	6,6 1,45			
40-250B	2,2	100L	18,3 0,73				18,2 1,13	17,9 1,19	17,7 1,24	17,1 1,39	16,2 1,51	14,9 1,62	12,9 1,73	10,7 1,82	8,3 1,89		
40-250A	2,2	100L	20,9 0,89				20,8 1,32	20,6 1,40	20,4 1,47	19,8 1,62	19,0 1,75	17,9 1,88	16,3 2,00	14,1 2,10	11,5 2,21	8,4 2,31	

TYPE	P <sub>2</sub> nom. kW	Motor Size	Q (m³/h - l/min)																
			0	9	10,5	12	15	18	21	24	27	30	33	36	39	42	45	48	54
			0	150	175	200	250	300	350	400	450	500	550	600	650	700	750	800	900
H (m) / pump input power (kW)																			
50-125B	0,55	80M	5,3 0,15	5,5 0,23	5,5 0,25	5,4 0,28	5,3 0,32	5,1 0,38	4,9 0,40	4,7 0,44	4,4 0,45	4,1 0,46	3,6 0,47	3,1 0,47	2,6 0,48	2,1 0,49			
50-125A	0,75	80M	6,2 0,23	6,4 0,38	6,4 0,39	6,3 0,41	6,1 0,44	6,0 0,48	5,8 0,51	5,5 0,55	5,2 0,59	4,8 0,62	4,4 0,63	3,9 0,64	3,4 0,64	2,9 0,63			
50-160B	0,75	80M	7,9 0,23	8,0 0,43	7,9 0,45	7,8 0,47	7,7 0,51	7,3 0,56	6,9 0,60	6,4 0,63	5,9 0,65	5,3 0,66	4,7 0,67	4,0 0,68	3,2 0,68	2,3 0,67			
50-160A	1,1	90S	9,4 0,34	9,4 0,55	9,4 0,57	9,3 0,59	9,2 0,65	9,0 0,72	8,7 0,77	8,3 0,80	7,8 0,82	7,2 0,84	6,7 0,86	6,0 0,87	5,4 0,88	4,7 0,88	3,9 0,89	3,1 0,88	
50-200C	1,1	90S	12,0 0,39	12,0 0,63	11,8 0,68	11,7 0,72	11,2 0,79	10,7 0,83	10,0 0,86	9,3 0,89	8,2 0,91	7,2 0,93	6,0 0,94	4,6 0,94	3,2 0,95				
50-200B	1,5	90L	13,1 0,48		13,1 0,77	13,1 0,83	12,7 0,92	12,2 1,02	11,6 1,09	10,9 1,14	10,0 1,18	9,2 1,22	8,2 1,24	7,0 1,27	5,7 1,27	4,2 1,27			
50-200A	1,5	90L	14,8 0,54		14,7 0,87	14,5 0,92	14,4 1,03	13,9 1,14	13,4 1,22	12,7 1,28	11,9 1,32	11,0 1,36	10,0 1,40	8,9 1,43	7,6 1,45	6,3 1,47	4,6 1,48		
50-250C	2,2	100L	17,9 0,58			17,7 1,24	17,4 1,32	16,9 1,47	16,4 1,59	15,8 1,71	14,9 1,80	14,2 1,89	13,4 1,97	12,4 2,04	11,0 2,10	9,5 2,16	7,5 2,22		
50-250B	3	100L	19,9 0,79			20,0 1,43	19,6 1,58	19,1 1,72	18,8 1,85	18,2 1,97	17,5 2,07	16,7 2,19	15,7 2,28	14,6 2,37	13,6 2,45	12,0 2,52	10,4 2,58	8,2 2,64	
50-250A	4	112M	23,0 0,90			22,9 1,62	22,7 1,84	22,5 2,07	22,2 2,21	21,8 2,42	21,1 2,60	20,4 2,78	19,5 2,95	18,7 3,12	17,7 3,28	16,6 3,43	15,2 3,53	13,4 3,62	8,4 3,74

TYPE	P <sub>2</sub> nom. kW	Motor Size	Q (m³/h - l/min)																			
			0	18	21	24	27	30	33	36	39	42	45	48	54	60	66	72	78	84	90	96
			0	300	350	400	450	500	550	600	650	700	750	800	900	1000	1100	1200	1300	1400	1500	1600
H (m) / pump input power (kW)																						
50-315C No EN 733	5,5	132M	24,4 1,64	24,7 2,58	24,7 2,77	24,6 2,96	24,5 3,15	24,3 3,33	24,0 3,50	23,7 3,66	23,4 3,82	23,1 3,96	22,8 4,11	22,5 4,24	21,9 4,51	21,1 4,77	20,2 5,01	19,2 5,23	18,1 5,43	16,8 5,62		
50-315B No EN 733	7,5	132M	31,3 2,35	31,4 3,54	31,4 3,78	31,3 4,01	31,3 4,24	31,2 4,47	30,9 4,68	30,6 4,89	30,3 5,08	29,9 5,27	29,5 5,46	29,1 5,64	28,2 5,99	27,3 6,32	26,5 6,61	25,5 6,89	24,4 7,14	23,1 7,37	21,6 7,58	
50-315A No EN 733	11	160M	37,5 3,06	37,2 4,39	37,2 4,65	37,1 4,92	37,0 5,18	36,9 5,45	36,7 5,72	36,5 5,97	36,3 6,22	36,0 6,45	35,6 6,68	35,2 6,90	34,3 7,31	33,3 7,69	32,1 8,04	30,9 8,37	29,7 8,69	28,4 8,96	26,9 9,18	25,1 9,37



# 4CA/4CAT - 4CAX EN 733 ~ 1450 r.p.m.

TYPE	P <sub>2</sub> nom. kW	Motor Size	Q (m³/h - l/min)																		
			0	18	21	24	27	30	33	36	39	42	45	48	54	60	66	72	78	84	90
			0	300	350	400	450	500	550	600	650	700	750	800	900	1000	1100	1200	1300	1400	1500
			H (m) / pump input power (kW)																		
65-125B	0,75	80M	4,9 0,31	5,1 0,48	5,1 0,50	5,0 0,53	5,0 0,55	4,9 0,57	4,7 0,60	4,6 0,63	4,5 0,64	4,3 0,66	4,0 0,67	3,8 0,68	3,3 0,69	2,8 0,68					
65-125A	1,1	90S	6,1 0,40	6,3 0,60	6,2 0,63	6,1 0,66	6,1 0,69	6,0 0,73	5,9 0,76	5,8 0,79	5,7 0,80	5,5 0,82	5,3 0,83	5,0 0,85	4,7 0,86	4,3 0,88	3,7 0,88	3,0			
65-160C	1,5	90L	7,3 0,44			7,6 0,80	7,5 0,85	7,3 0,89	7,2 0,93	7,0 0,96	6,8 0,99	6,7 1,01	6,4 1,02	6,2 1,04	5,7 1,07	5,1 1,12	4,4 1,13	3,6 1,13	2,9 1,13		
65-160B	1,5	90L	8,4 0,47			8,6 0,86	8,4 0,90	8,3 0,95	8,2 1,01	8,0 1,06	7,8 1,11	7,6 1,14	7,4 1,17	7,2 1,19	6,5 1,25	5,9 1,28	5,2 1,31	4,4 1,33	3,6 1,34		
65-160A	2,2	100L	9,8 0,66			9,9 1,06	9,9 1,14	9,8 1,20	9,6 1,25	9,5 1,30	9,3 1,34	9,1 1,39	8,9 1,42	8,7 1,46	8,2 1,52	7,6 1,58	6,8 1,63	6,1 1,67	5,3 1,72	4,6 1,72	
65-200C	2,2	100L	11,0 0,48				11,6 1,26	11,5 1,35	11,4 1,44	11,3 1,53	11,2 1,60	10,9 1,66	10,5 1,72	10,3 1,79	9,7 1,90	9,1 1,96	8,3 2,01	7,4 2,06	6,5 2,11	5,0 2,14	
65-200B	3	100L	12,3 0,69				13,1 1,45	13,0 1,51	12,8 1,61	12,7 1,70	12,5 1,77	12,3 1,88	12,1 1,95	11,9 2,01	11,3 2,11	10,6 2,21	10,0 2,29	9,0 2,36	8,0 2,42	7,0 2,48	
65-200A	3	100L	14,0 1,12				14,8 1,74	14,7 1,82	14,6 1,92	14,5 2,02	14,2 2,10	14,0 2,18	13,9 2,28	13,7 2,34	13,3 2,48	12,7 2,59	12,0 2,70	11,3 2,81	10,3 2,91	9,3 3,00	
65-250B	4	112M	20,6			21,0	20,8	20,4	20,1	19,8	19,3	18,8	18,4	17,3	16,0	14,5	12,9	11,2	8,7		
	5,5	132S	1,42			2,87	2,98	3,18	3,38	3,50	3,61	3,70	3,78	3,87	3,97	4,07	4,17	4,19	4,21		
65-250A	5,5	132S	22,8 1,58				22,9 3,41	22,5 3,56	22,1 3,70	21,7 3,79	21,4 3,88	20,9 4,00	20,4 4,11	19,2 4,31	17,6 4,44	16,9 4,58	15,4 4,71	13,6 4,75	11,5 4,79	8,8 4,80	

TYPE	P <sub>2</sub> nom. kW	Motor Size	Q (m³/h - l/min)																								
			0	27	30	33	36	39	42	45	48	54	60	66	72	78	84	90	96	102	108	114	120	126	132	138	
			0	450	500	550	600	650	700	750	800	900	1000	1100	1200	1300	1400	1500	1600	1700	1800	1900	2000	2100	2200	2300	
			H (m) / pump input power (kW)																								
65-315CM	7,5	132M	23,0 2,05	23,5 3,38	23,5 3,55	23,4 3,70	23,3 3,86	23,2 4,01	23,1 4,16	22,9 4,32	22,7 4,47	22,3 4,77	21,9 5,05	21,5 5,33	21,0 5,59	20,5 5,84	20,0 6,08	19,3 6,32	18,5 6,56	17,7 6,77	16,9 6,97	16,0 7,16	15,0 7,35	13,9 7,52			
65-315BM	11	160M	28,9 2,72	28,9 4,33	28,9 4,52	28,8 4,70	28,7 4,89	28,6 5,07	28,4 5,24	28,2 5,42	28,0 5,61	27,5 5,98	27,0 6,33	26,5 6,65	25,9 6,95	25,3 7,24	24,7 7,53	24,0 7,80	23,3 8,06	22,5 8,30	21,6 8,52	20,6 8,72	19,6 8,91	18,4 9,10	17,2 9,29		
65-315AM	11	160M	34,5 3,44	34,0 5,43	33,9 5,66	33,7 5,88	33,5 6,10	33,3 6,32	33,1 6,54	32,9 6,75	32,6 6,96	32,2 7,35	31,6 7,73	31,0 8,10	30,4 8,45	29,6 8,78	28,9 9,08	28,1 9,35	27,2 9,61	26,2 9,84	25,1 10,05	23,8 10,24	22,5 10,40	21,1 10,55	19,6 10,68	18,2 10,78	

TYPE	P <sub>2</sub> nom. kW	Motor Size	Q (m³/h - l/min)																					
			0	24	27	30	33	36	42	48	60	72	84	96	102	108	120	132	144					
			0	400	450	500	550	600	700	800	1000	1200	1400	1600	1700	1800	2000	2200	2400					
			H (m) / pump input power (kW)																					
80-160E	1,1	90S	5,5 0,35	5,7 0,71	5,7 0,74	5,7 0,74	5,6 0,78	5,4 0,81	5,1 0,88	4,9 0,90	4,2 0,97	3,8 1,02	2,8 1,02	2,2 1,00										
80-160D	1,5	90L	6,3 0,61			6,8 0,89	6,7 0,91	6,6 0,95	6,5 0,98	6,3 1,04	6,1 1,10	5,5 1,19	4,8 1,25	4 1,28	3,1 1,30	2,6 1,29								
80-160C	1,5	90L	7,0 0,67			7,4 1,04	7,3 1,08	7,3 1,12	7,1 1,18	6,8 1,25	6,4 1,35	5,7 1,42	4,9 1,47	4 1,48	3,5 1,48	3,1 1,48								
80-160B	2,2	100L	8,5 0,62				8,9 1,29	8,9 1,35	8,7 1,43	8,5 1,51	8,0 1,72	7,5 1,87	6,8 1,95	5,7 2,01	5,2 2,02	4,7 2,04	3,5 2,04							
80-160A	3	100L	9,3 1,09					9,8 1,60	9,7 1,71	9,5 1,81	9,1 2,01	8,6 2,14	7,9 2,27	7,1 2,34	6,6 2,37	6,2 2,39	5,0 2,42	3,8 2,43						
80-200B	4	112M	12,3 1,25						13,1 2,32	13,0 2,48	12,6 2,79	12,1 3,03	11,4 3,26	10,5 3,45	10,1 3,52	9,6 3,58	8,4 3,69	7,1 3,75						
80-200A	5,5	132S	13,8 1,40						14,7 2,64	14,6 2,81	14,2 3,14	13,7 3,43	13,1 3,66	12,3 3,87	11,7 3,99	11,2 4,09	10,1 4,21	8,8 4,30	7,5 4,35					
80-250B	5,5	132S	18,9 1,79						19,2 3,52	19,0 3,75	18,1 4,14	17,0 4,48	15,9 4,78	14,8 5,05	14,2 5,16	13,6 5,24	12,4 5,41	11,1 5,54						
80-250A	7,5	132S	22,4 2,22						22,9 4,28	22,6 4,56	21,8 5,05	20,7 5,46	19,6 5,85	18,3 6,21	17,7 6,37	17,0 6,52	15,6 6,77	14,2 6,96	12,6 7,10					

TYPE	P <sub>2</sub> nom. kW	Motor Size	Q (m³/h - l/min)																					
			0	42	48	60	72	84	96	102	108	120	132	144	150	156	168							
			0	700	800	1000	1200	1400	1600	1700	1800	2000	2200	2400	2500	2600	2800							
			H (m) / pump input power (kW)																					
80-315B	11	160M	27,7 2,99	28,3 5,48	28,2 5,88	27,9 6,67	27,2 7,42	26,4 8,09	25,4 8,67	24,9 8,95	24,4 9,21	23,3 9,74	21,9 10,28	20,5 10,66	19,9 10,85									
80-315A	15	160L	34,5 4,29	35,0 7,30	34,9 7,78	34,6 8,75	34,0 9,66	33,3 10,53	32,4 11,37	31,9 11,77	31,3 12,17	30,1 12,91	28,8 13,50	27,3 14,05	26,4 14,31	25,5 14,56	23,7 15,04							



# 4CA/4CAT - 4CAX EN 733 ~ 1450 r.p.m.

TYPE	P <sub>2</sub> nom. kW	Motor Size	Q (m <sup>3</sup> /h - l/min)																
			0	48	60	72	84	96	102	108	120	132	144	150	156	168	180	192	204
			0	800	1000	1200	1400	1600	1700	1800	2000	2200	2400	2500	2600	2800	3000	3200	3400
			H (m) / pump input power (kW)																
100-200B	5,5	132S	13,5 2,79	13,6 3,48	13,4 3,70	13,1 3,93	12,8 4,15	12,5 4,38	12,3 4,49	12,1 4,59	11,6 4,77	11,0 4,93	10,3 5,05	9,9 5,09	9,5 5,13	8,7 5,19	7,8 5,23		
100-200A	7,5	132M	15,2 3,12	15,4 3,96	15,3 4,22	15,0 4,48	14,8 4,74	14,5 5,03	14,4 5,17	14,2 5,31	13,8 5,58	13,2 5,80	12,5 5,99	12,2 6,07	11,8 6,13	11,0 6,23	10,1 6,33	9,1 6,40	
100-250E	7,5	132M	16,7 3,06		16,9 4,71	16,8 5,06	16,6 5,42	16,3 5,75	16,2 5,91	16,0 6,07	15,5 6,39	14,8 6,69	14,0 6,96	13,6 7,08	13,2 7,19	12,4 7,38	11,4 7,53		
100-250D	7,5	132M	19,6 3,39		19,6 5,44	19,4 5,88	19,2 6,29	18,9 6,66	18,7 6,82	18,5 6,98	18,0 7,30	17,4 7,60	16,6 7,90	16,2 8,05	15,7 8,19	14,8 8,41	13,7 8,60	12,7 8,75	
100-250A	11	160M	22,6 3,96		22,3 6,17	22,1 6,67	21,8 7,15	21,4 7,59	21,2 7,80	21,0 8,00	20,5 8,37	19,9 8,71	19,1 9,04	18,7 9,20	18,3 9,36	17,3 9,63	16,1 9,85	15,0 10,04	13,8 10,19

TYPE	P <sub>2</sub> nom. kW	Motor Size	Q (m <sup>3</sup> /h - l/min)																
			0	72	84	96	102	108	120	132	144	150	156	168	180	192	204	216	
			0	1200	1400	1600	1700	1800	2000	2200	2400	2500	2600	2800	3000	3200	3400	3600	
			H (m) / pump input power (kW)																
100-315B	15	160L	31,8 4,74	31,4 9,27	30,6 10,05	29,8 9,67	29,4 10,05	29,0 11,42	28,2 11,10	27,3 12,54	26,3 12,27	25,8 12,54	25,3 13,54	24,2 13,06	23,0 14,31	21,4 13,54	19,7 14,92	17,9 15,14	
100-315A	18,5	180M	37,1 5,63	36,5 11,03	35,7 11,94	34,9 12,80	34,4 13,21	34,0 13,60	33,1 14,33	32,2 15,01	31,2 15,69	30,7 16,02	30,2 16,32	29,1 16,86	27,9 17,32	26,3 17,76	24,7 18,15	23,1 18,49	

TYPE	P <sub>2</sub> nom. kW	Motor Size	Q (m <sup>3</sup> /h - l/min)																	
			0	84	96	102	108	120	132	144	150	156	168	180	192	204	216	228	240	252
			0	1400	1600	1700	1800	2000	2200	2400	2500	2600	2800	3000	3200	3400	3600	3800	4000	4200
			H (m) / pump input power (kW)																	
100-400C	22	180L	42,4 6,93	40,6 14,36	39,8 15,34	39,3 15,81	38,8 16,27	37,8 17,14	36,7 17,98	35,5 18,83	34,9 19,25	34,3 19,64	32,8 20,30	31,4 20,95	30,3 21,50	29,1 21,91	27,7 22,31	25,8 22,70		
100-400B	30	200L	50,3 9,32	48,7 18,20	47,9 19,51	47,5 20,14	47,0 20,75	44,9 21,93	43,8 23,04	43,2 24,07	42,6 24,56	41,3 25,03	39,8 25,95	38,2 26,80	36,5 27,61	34,7 28,36	33,1 29,01	31,6 29,56	30,00	
100-400A	37	225S	58,3 11,46	56,0 21,50	55,2 23,05	54,8 23,80	54,3 24,54	53,4 25,95	52,4 27,31	51,3 28,63	50,7 29,27	50,1 29,89	48,7 31,07	47,3 32,15	45,8 33,12	44,3 34,00	42,7 34,77	40,9 35,48	38,8 36,11	36,7 36,69

TYPE	P <sub>2</sub> nom. kW	Motor Size	Q (m <sup>3</sup> /h - l/min)																
			0	102	108	120	132	144	150	156	168	180	192	204	216	228	240	252	276
			0	1700	1800	2000	2200	2400	2500	2600	2800	3000	3200	3400	3600	3800	4000	4200	4600
			H (m) / pump input power (kW)																
125-250B	11	160M	19,6 5,41	20,2 8,04	20,0 8,22	19,7 8,56	19,2 8,80	18,8 9,30	18,5 9,50	18,2 9,66	17,6 9,99	16,9 10,23	16,1 10,44	15,2 10,67	14,3 10,88	13,3 11,02	12,2 11,12	11,1 11,18	
125-250A	15	160L	23,2 6,18	24,0 9,71	23,8 9,92	23,5 10,36	23,2 10,80	22,8 11,24	22,6 11,47	22,4 11,70	21,9 12,16	21,3 12,60	20,7 13,02	20,0 13,42	19,3 13,77	18,5 14,08	17,6 14,34	16,6 14,57	14,7 14,94

TYPE	P <sub>2</sub> nom. kW	Motor Size	Q (m <sup>3</sup> /h - l/min)																	
			0	120	132	144	150	156	168	180	192	204	216	228	240	252	276	348	372	396
			0	2000	2200	2400	2500	2600	2800	3000	3200	3400	3600	3800	4000	4200	4600	5800	6200	6600
			H (m) / pump input power (kW)																	
125-315C	22	180L	24,1 7,23	25,8 12,72	25,7 13,39	25,5 14,05	25,4 14,38	25,3 14,70	25,0 15,34	24,7 15,95	24,4 16,49	24,1 16,99	23,7 17,48	23,3 17,98	22,8 18,49	22,2 18,99	21,0 19,96	15,7 22,32		
125-315B	30	200L	31,5 9,52	33,0 16,73	33,0 17,53	32,9 18,36	32,8 18,77	32,4 19,15	32,1 19,84	32,1 20,43	31,7 21,01	31,3 21,67	31,0 22,39	30,6 23,13	30,1 23,83	29,6 24,48	28,3 25,71	24,2 29,14	22,2 30,13	
125-315A	37	225S	38,6 11,88	39,6 20,51	39,5 21,40	39,2 22,29	39,0 22,73	38,8 23,17	38,4 24,03	38,1 24,84	37,9 25,60	37,6 26,36	37,3 27,14	37,0 27,97	36,6 28,82	36,2 29,66	35,2 31,26	29,6 35,58	28,2 36,82	
125-400C	45	225M	46,2 13,91	47,6 24,65	47,5 25,83	47,2 27,03	47,0 27,62	46,9 28,20	46,5 29,31	46,1 30,30	45,7 31,22	45,2 32,17	44,7 33,24	44,2 34,42	43,7 35,62	43,2 36,73	42,4 38,53	36,5 43,95	33,8 45,52	
125-400B	55	250M	53,4 16,79	54,5 28,74	54,3 30,15	54,1 31,55	54,0 32,25	53,9 32,94	53,5 34,30	53,2 35,60	52,7 36,85	52,3 38,07	51,7 39,30	51,2 40,56	50,6 41,82	50,0 43,06	48,8 45,43	44,6 51,75	39,1 55,27	
125-400A	75	280S	58,6 18,95	59,5 31,66	59,4 33,20	59,2 34,74	59,1 35,52	59,0 36,29	58,7 37,81	58,3 39,30	57,8 40,77	57,4 42,22	56,8 43,66	56,3 45,09	55,7 46,50	55,1 47,87	53,9 50,49	49,9 57,63	47,2 59,76	45,0 61,83



# 4CA/4CAT - 4CAX EN 733 ~ 1450 r.p.m.

TYPE	P <sub>2</sub> nom. kW	Motor Size	Q (m³/h - l/min)																			
			0	144	150	156	168	180	192	204	216	228	240	252	276	348	372	396	444	492	540	564
			0	2400	2500	2600	2800	3000	3200	3400	3600	3800	4000	4200	4600	5800	6200	6600	7400	8200	9000	9400
			H (m) / pump input power (kW)																			
150-315D	30	200L	25,7 12,22	28,3 18,44	28,3 18,74	28,3 19,04	28,2 19,63	28,1 20,19	27,9 20,71	27,7 21,22	27,5 21,72	27,2 22,23	26,8 22,73	26,5 23,25	25,8 24,37	24,7 27,81	23,8 28,75	22,7 29,56	19,6 30,78			
150-315C	37	225S	29,6 14,01	32,2 21,16	32,2 21,49	32,3 21,84	32,2 22,52	32,1 23,20	31,9 23,85	31,6 24,45	31,3 25,02	31,0 25,58	30,7 26,14	30,2 26,73	28,6 28,01	27,9 31,79	27,0 32,95	24,7 34,00	21,8 35,84			
150-315B	45	225M	34,0 16,47	36,3 24,33	36,2 24,72	36,2 25,12	36,1 25,92	36,0 26,72	35,7 27,47	35,5 28,17	35,4 28,85	35,2 29,51	34,9 30,15	34,5 30,83	32,8 32,25	32,2 36,29	31,3 37,54	29,3 38,77	26,9 41,13	23,6 43,09		
150-315A	55	250M	39,4 18,39	41,0 27,78	41,0 28,22	40,8 28,66	40,8 29,55	40,8 30,43	40,6 31,31	40,3 32,18	40,0 33,05	39,7 33,92	39,5 34,77	39,2 35,59	37,6 37,10	36,6 41,75	35,8 43,40	34,1 45,02	31,7 48,12	28,9 50,36	27,2 52,60	25,5 53,65

TYPE	P <sub>2</sub> nom. kW	Motor Size	Q (m³/h - l/min)																			
			0	168	180	192	204	216	228	240	252	276	348	372	396	444	492	540	564	588	612	
			0	2800	3000	3200	3400	3600	3800	4000	4200	4600	5800	6200	6600	7400	8200	9000	9400	9800	10200	
			H (m) / pump input power (kW)																			
150-400C	75	280S	45,6 20,78	47,8 35,35	47,7 36,41	47,6 37,46	47,4 38,54	47,2 39,58	47,0 40,43	46,7 41,65	46,5 42,62	45,8 44,48	43,9 50,44	43,1 52,51	42,0 54,34	39,2 57,61	35,8 60,59	31,5 63,18	28,7 64,43			
150-400B	75	280S	52,8 26,57	54,4 41,90	54,2 43,10	53,9 44,29	57,3 45,48	53,5 46,65	53,2 47,81	52,9 48,96	52,6 50,10	51,8 52,35	50,3 58,79	49,8 60,86	48,9 62,94	46,1 66,80	42,9 70,20	39,1 73,30	36,7 74,72	34,3 76,14		
150-400A	90	280M	59,0 29,82	60,3 47,01	60,2 48,30	60,0 49,59	59,8 50,88	59,9 52,18	59,4 53,48	59,1 54,78	58,8 56,10	58,1 58,76	56,4 66,15	56,0 68,45	55,3 70,93	53,3 75,79	50,6 79,82	46,7 83,73	44,5 85,61	42,2 87,41	39,8 89,16	

# 4CA - 4CAX ~ 1450 r.p.m.

**Macchine a completamento gamma, non contemplate nella normativa EN 733.**  
**Machines complementing the existing range, not envisaged in the EN 733 standard.**  
**Máquinas para completar la gama, no contempladas en la norma EN 733.**  
**Machines venant compléter la gamme, non couvertes par la norme EN 733.**

TYPE	P <sub>2</sub> nom. kW	Motor Size	Q (m³/h - l/min)																			
			0	200	250	400	600	800	850	900												
			0	3333	4167	6667	10000	13333	14167	15000												
			H (m) / pump input power (kW)																			
200-315D	37	225S	21,2 18,00	21,7 24,31	21,8 26,11	21,2 31,21	18,3 36,07	12,5 37,00														
200-315C	45	225M	26,6 21,54	26,6 29,42	26,4 31,44	25,9 37,61	23,1 43,07	16,9 45,42	14,6 45,55													
200-315B	55	250M	33,4 25,04	33,4 36,30	33,2 38,91	32,2 46,32	28,6 52,72	21,7 55,67	19,4 55,62	16,7 55,25												
200-315A	75	280S	36,3 27,90	35,9 39,49	35,8 42,13	35,0 50,07	31,8 58,82	24,9 62,36	22,5 62,45	19,8 62,15												
200-400C	90	280M	43,0 31,27	44,1 45,90	44,1 50,14	43,6 62,49	39,9 77,58	31,5 89,60														
200-400B	110	315S	49,5 40,00	50,8 54,29	51,0 58,92	50,6 73,89	47,2 91,32	39,5 105,65	36,6 108,43													
200-400A	132	315M	57,2 49,00	58,5 65,01	58,6 70,26	58,2 87,26	55,2 107,05	48,2 124,54	45,6 128,46	44,0 132,15												

TYPE	P <sub>2</sub> nom. kW	Motor Size	Q (m³/h - l/min)																						
			0	250	400	600	800	850	900	1100	1170	1200	1300	1400	1500	1600									
			0	4167	6667	10000	13333	14167	15000	18333	19500	20000	21667	23333	25000	26667									
			H (m) / pump input power (kW)																						
250-315C	55	280M	26,1	25,5	25,3	24,1	22,3	21,7	21,0	16,8															
	75	280S	28,00	37,82	44,23	51,71	57,65	58,82	59,57	59,89															
250-315B	75	280S	33,2 43,46	33,0 54,77	32,7 61,20	31,8 68,72	29,6 74,57	28,6 75,26	27,5 75,64	21,7 74,47	19,0 73,35														
250-315A	90	280M	35,8 46,41	35,0 57,61	34,4 64,50	33,3 73,28	31,3 78,44	30,4 79,01	29,3 79,32	23,0 78,27	20,7 77,03	20,0 76,36													
250-400D	110	315S	38,3	39,9	39,9	39,0	36,9	36,1	35,2	30,6	28,6	27,7	24,3												
	132	315M	48,00	61,74	71,25	84,15	95,73	98,36	100,80	108,97	111,27	112,17	114,78												
250-400C	160	315L	53,83	71,89	83,20	98,11	112,06	115,25	118,20	128,07	130,85	131,93	135,08	137,50											
250-400B	160	315L	50,0	51,7	51,8	51,0	49,0	48,4	47,6	43,9	42,3	41,5	38,5	34,8	30,3										
	200	315L	64,57	84,18	97,49	115,36	131,10	134,76	138,27	151,48	155,58	157,12	161,60	164,88	167,09										
250-400A	200	315L	55,7 70,94	57,4 91,89	57,5 106,81	56,5 127,19	54,5 145,00	53,8 149,18	53,0 153,24	49,4 168,92	47,9 173,94	47,1 175,86	44,3 181,62	40,8 186,11	36,6 189,07	31,7 190,57									





# 4CA/4CAT - 4CAX EN 733 ~ 1450 r.p.m.

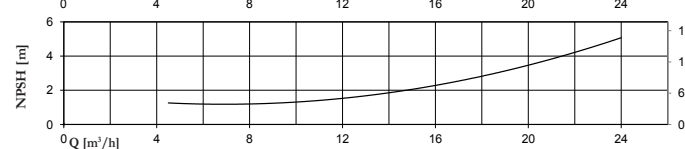
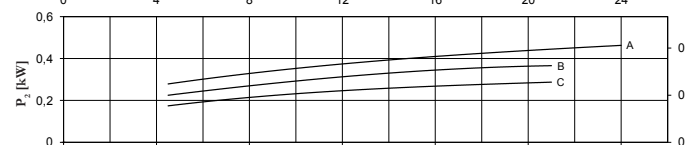
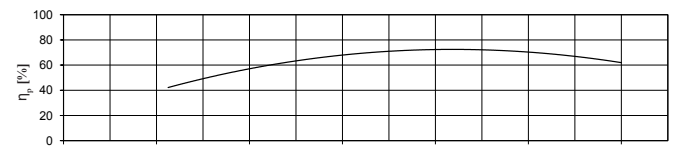
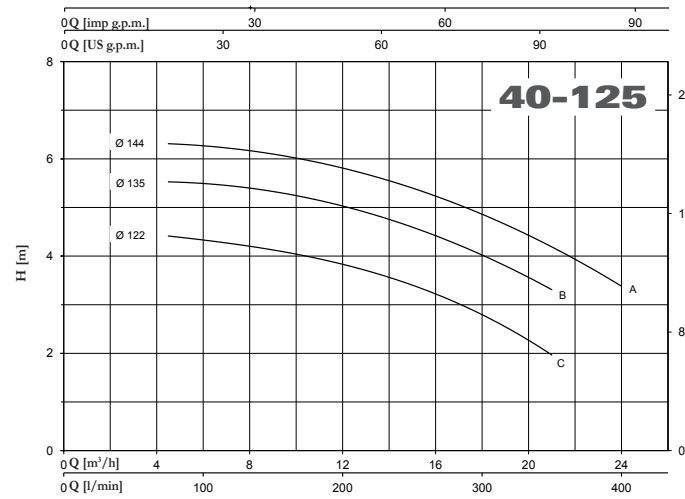
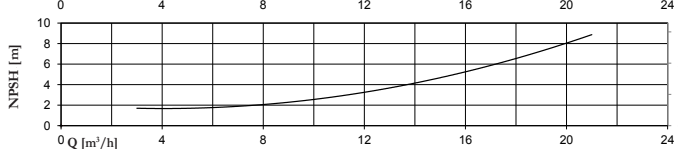
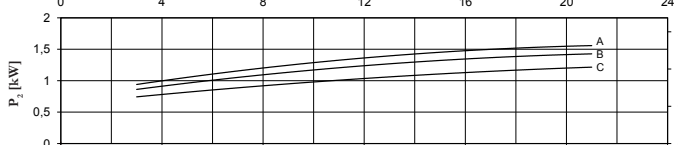
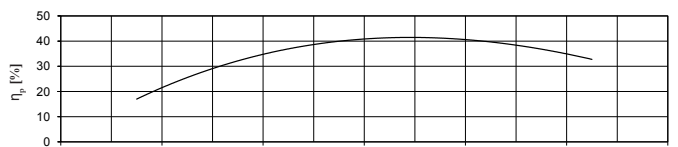
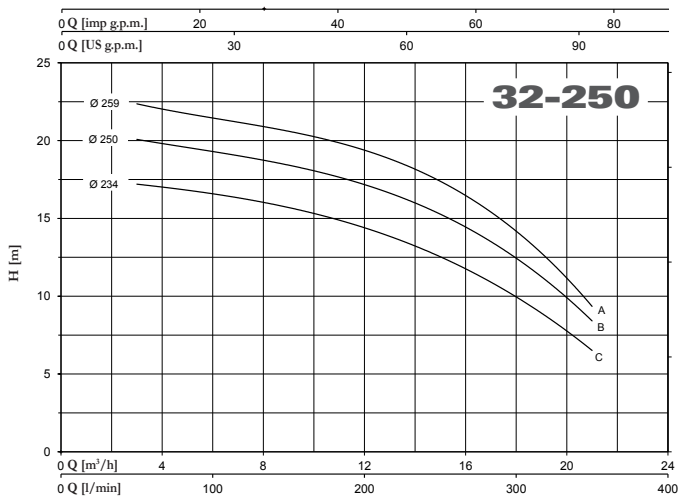
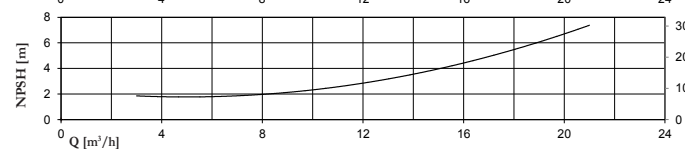
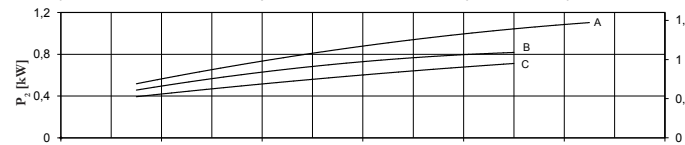
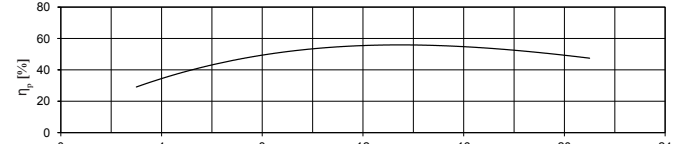
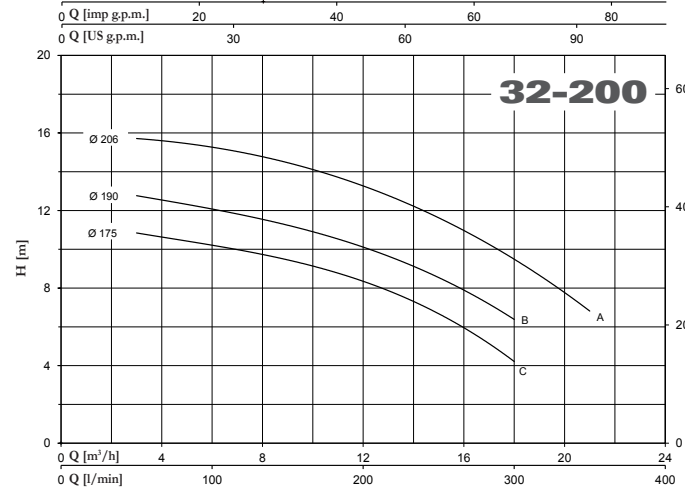
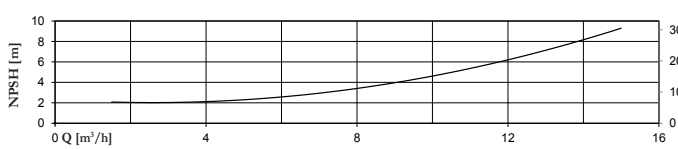
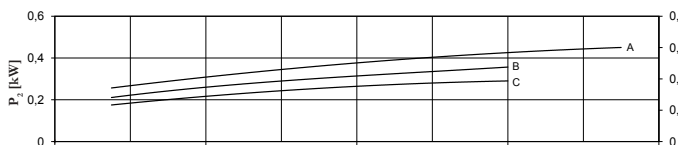
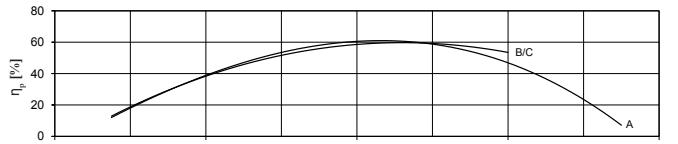
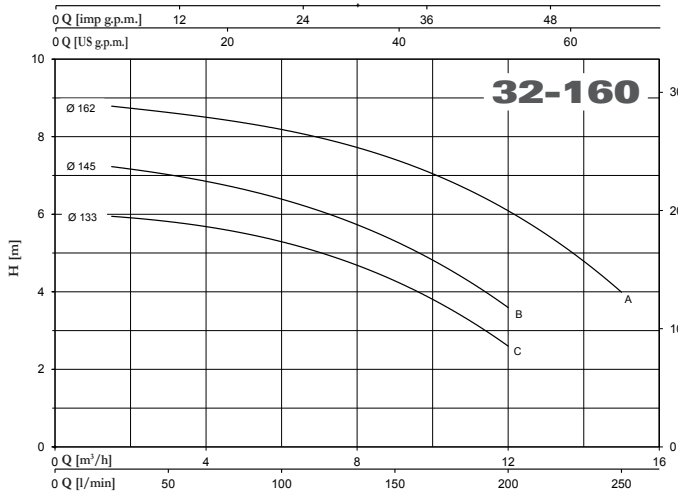

# 4CA/4CAT - 4CAX EN 733 ~ 1450 r.p.m.

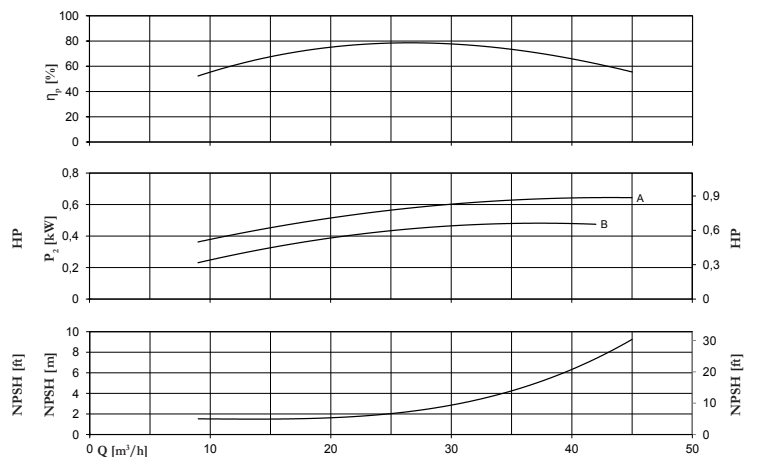
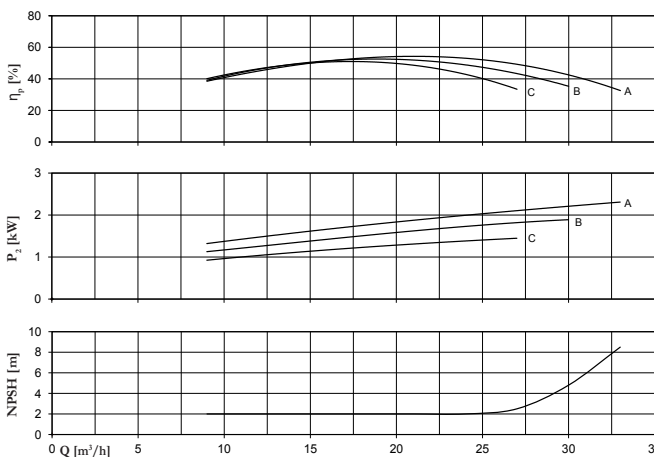
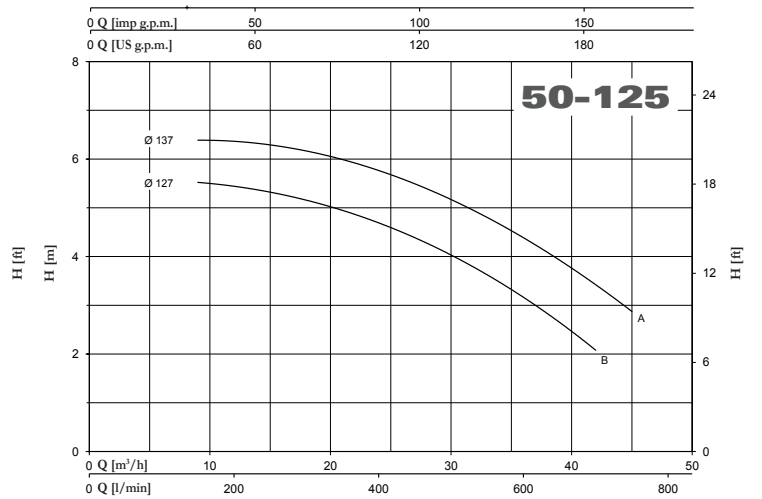
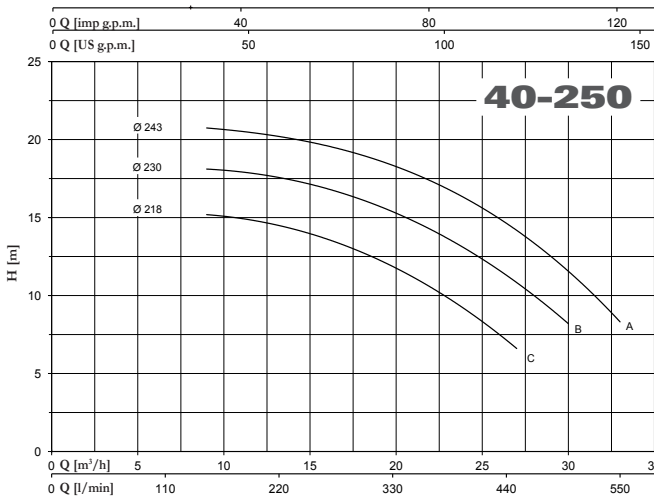
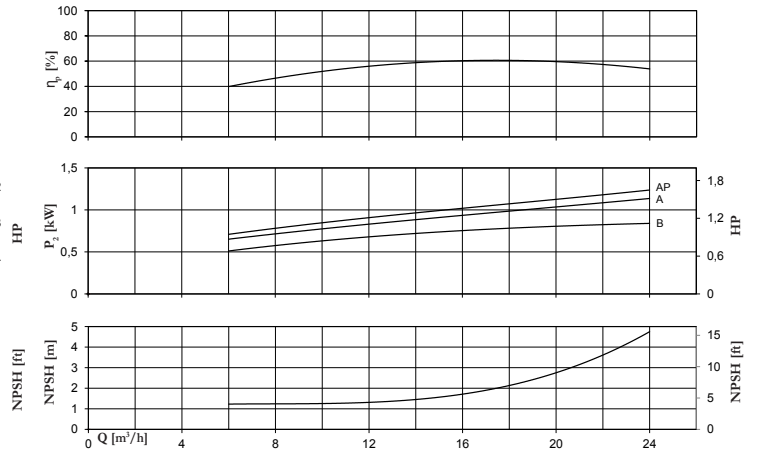
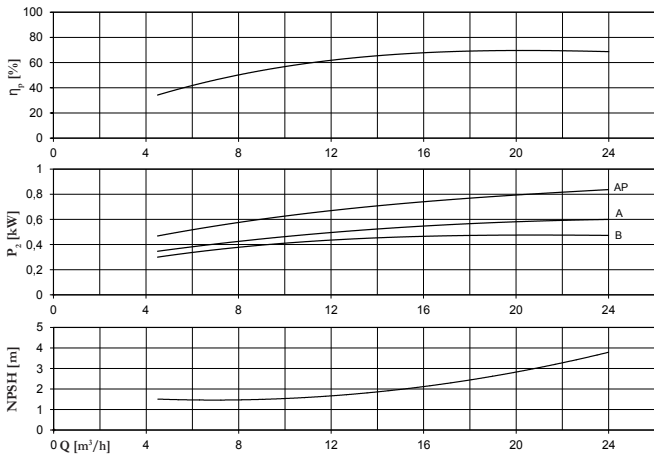
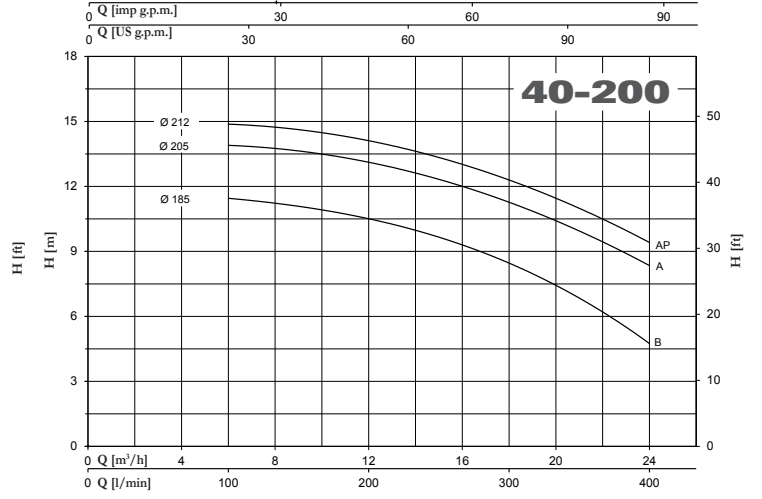
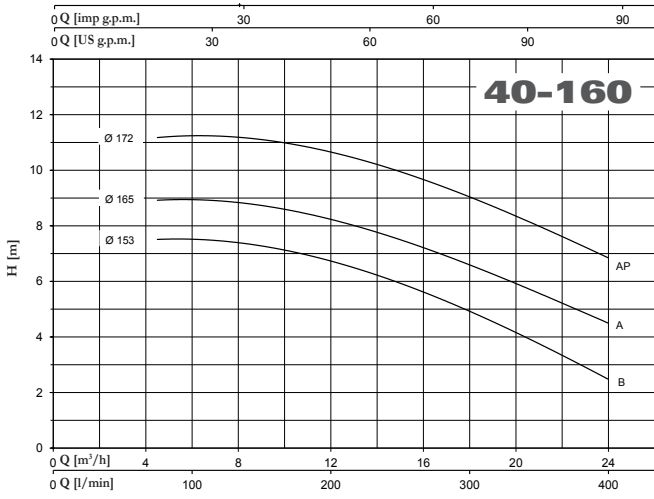

# 4CA/4CAT - 4CAX EN 733 ~ 1450 r.p.m.

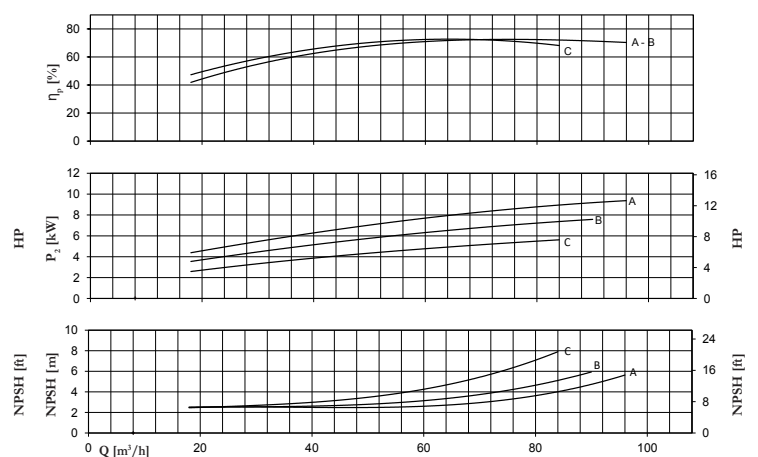
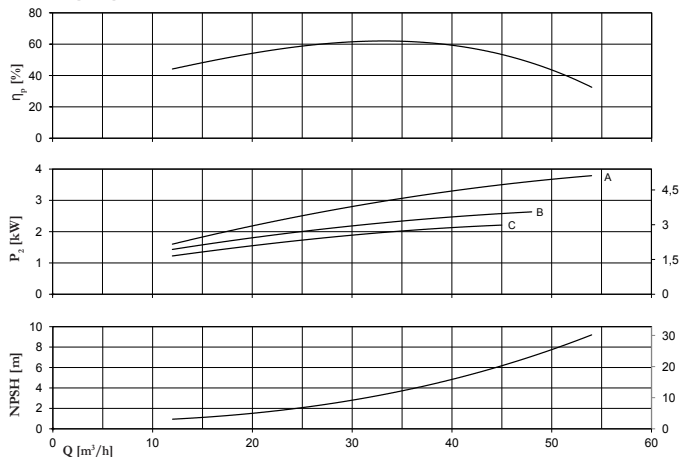
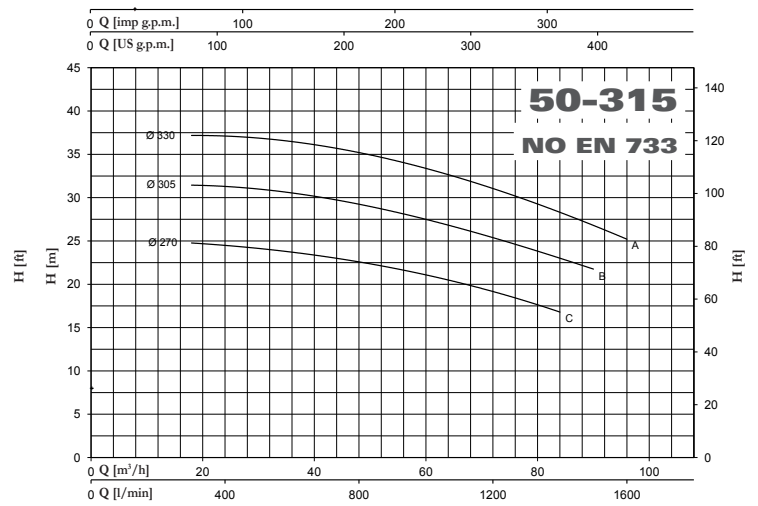
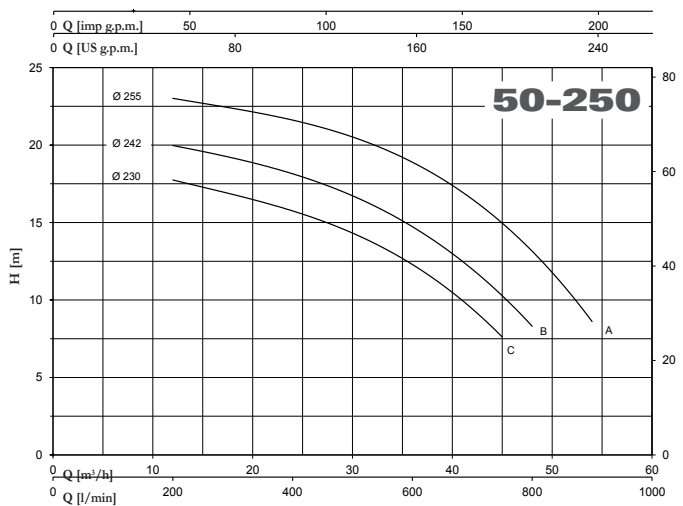
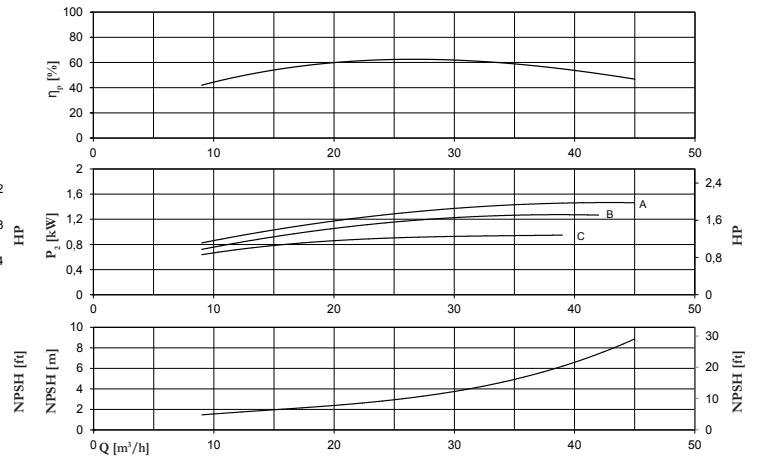
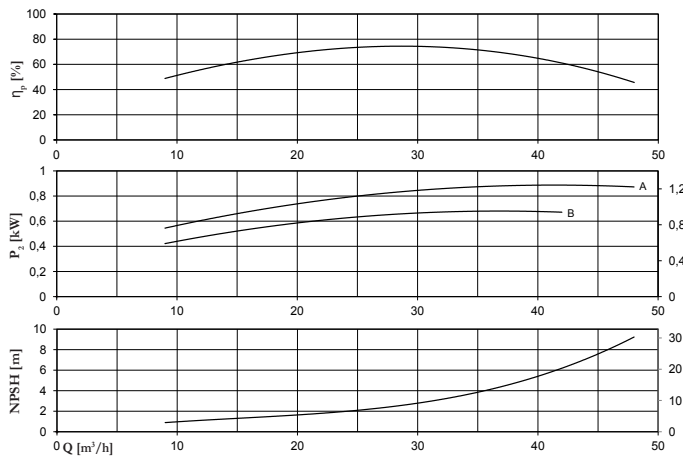
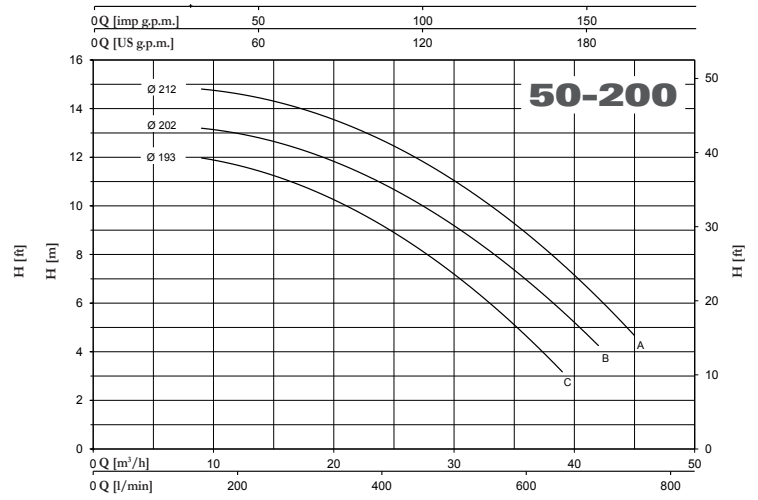
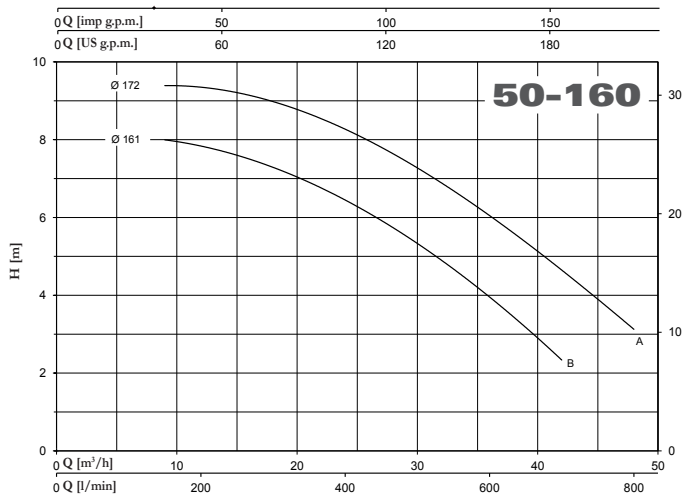

# 4CA/4CAT - 4CAX EN 733 ~ 1450 r.p.m.

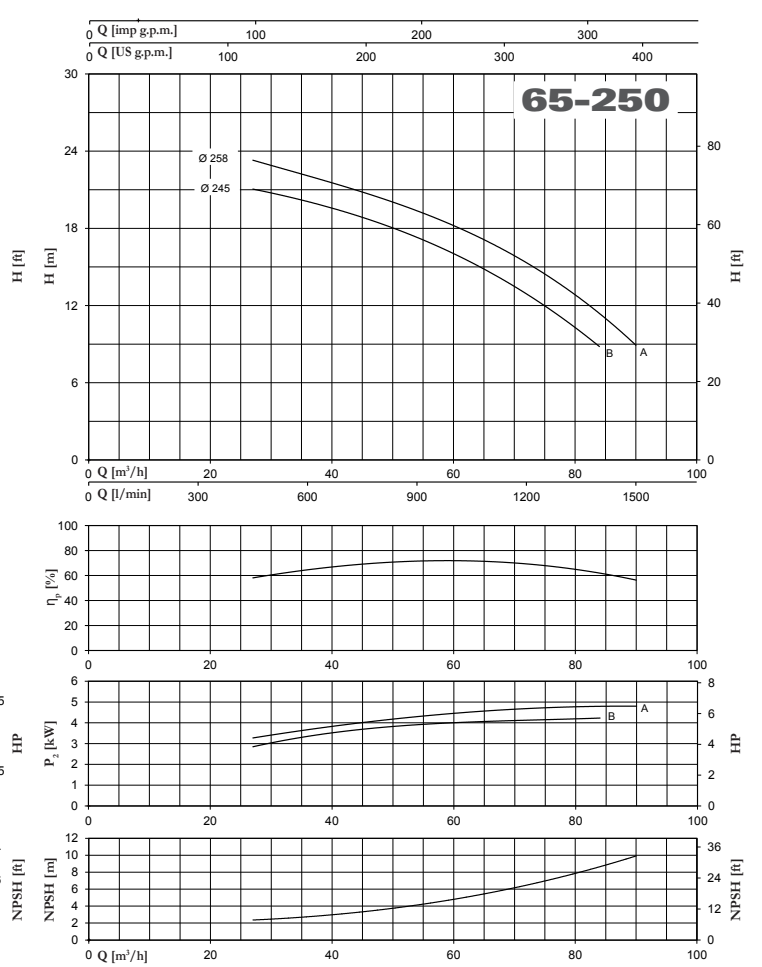
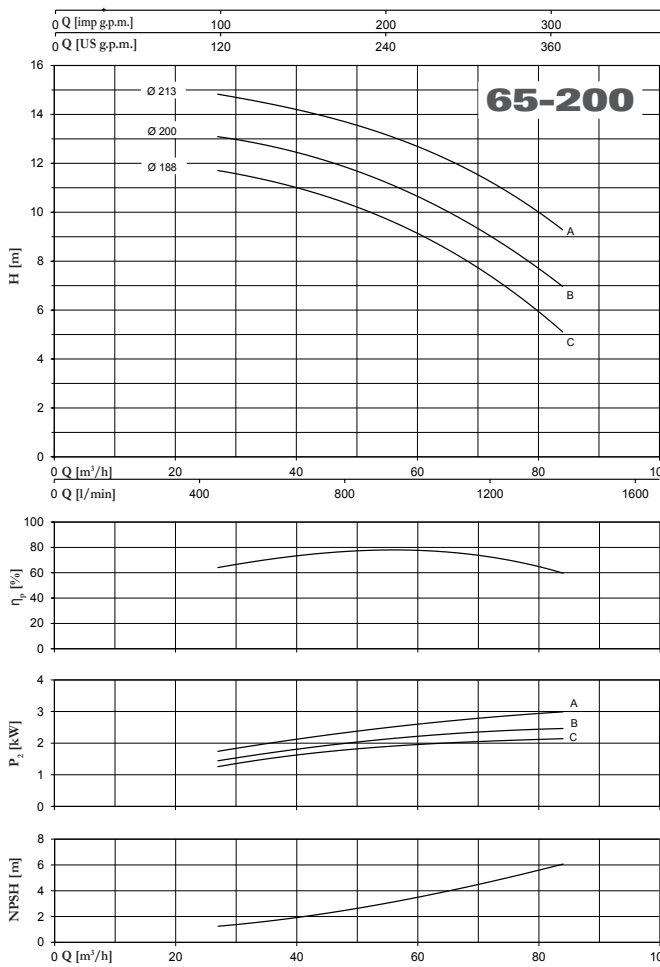
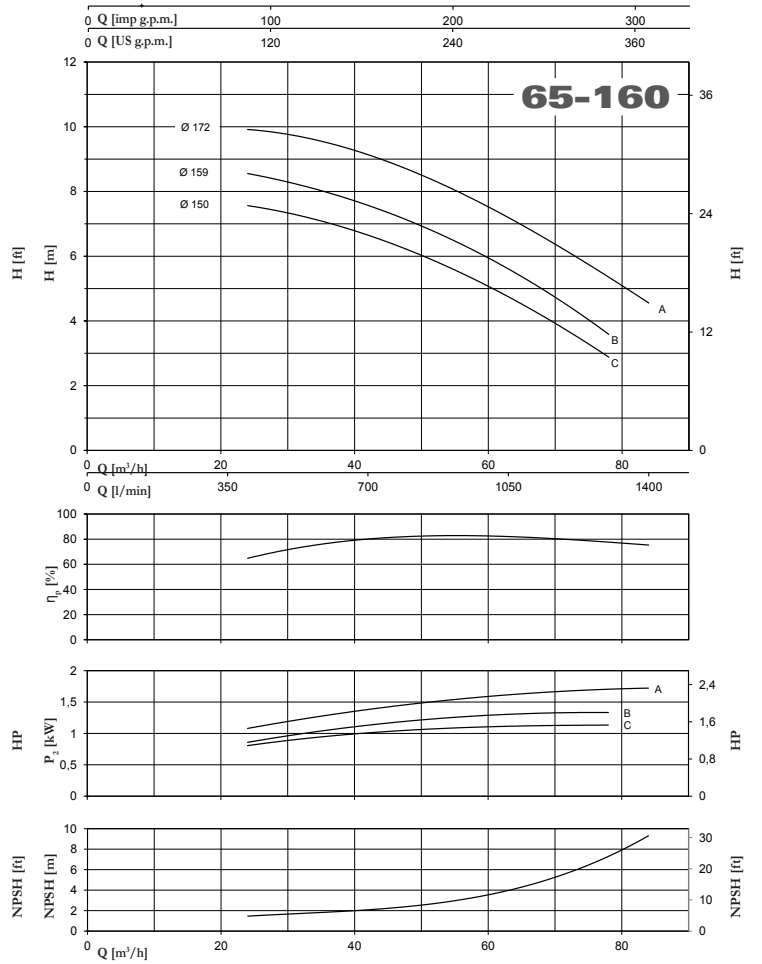
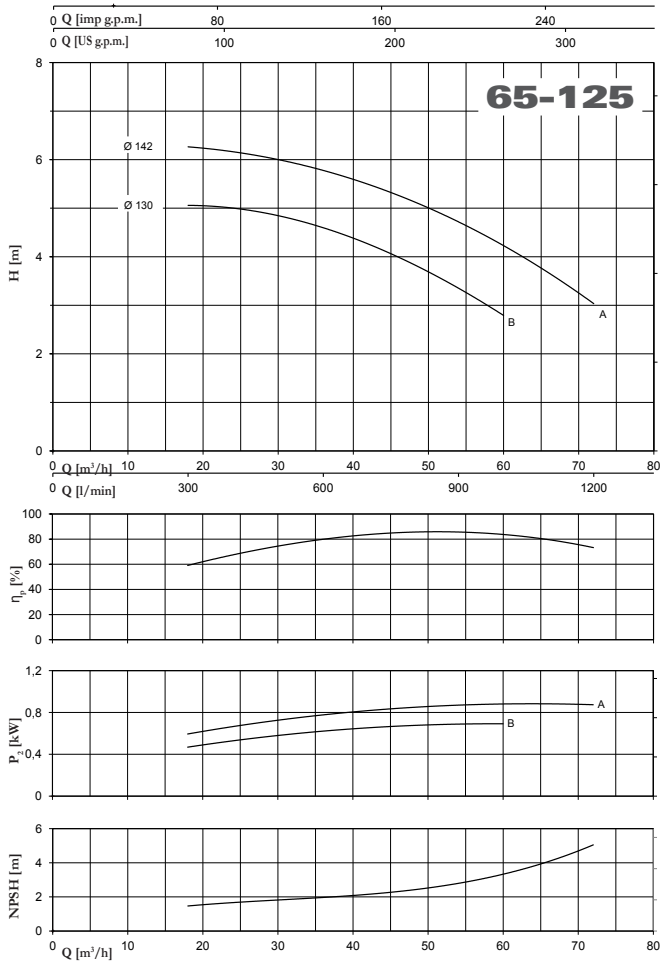

# 4CA/4CAT - 4CAX EN 733 ~ 1450 r.p.m.

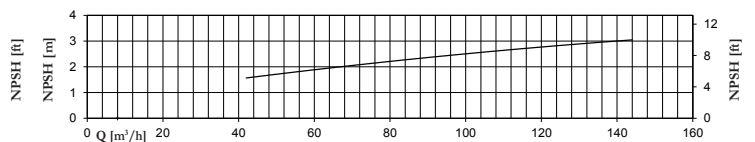
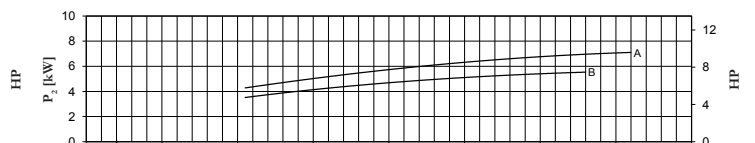
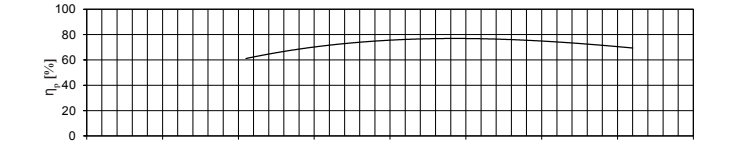
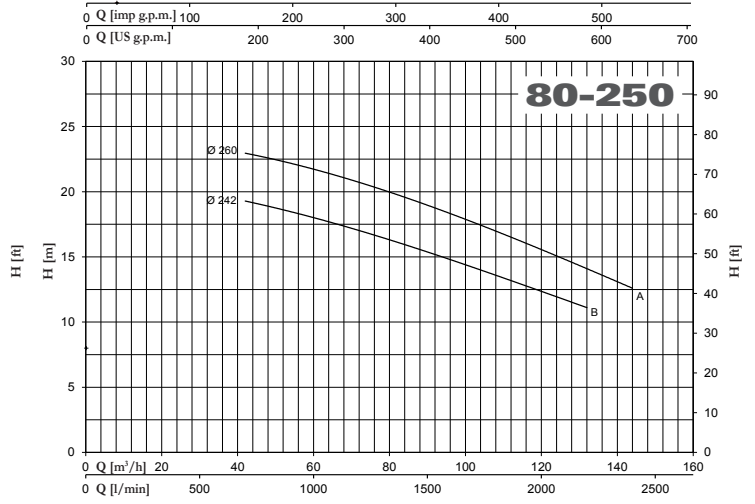
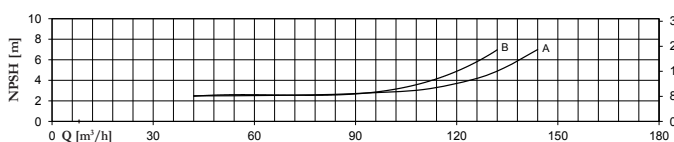
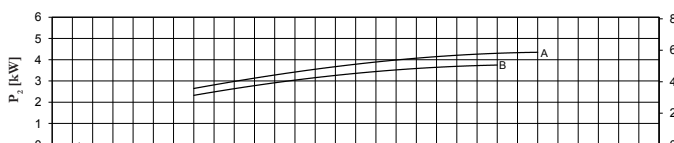
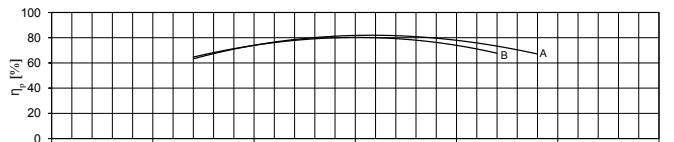
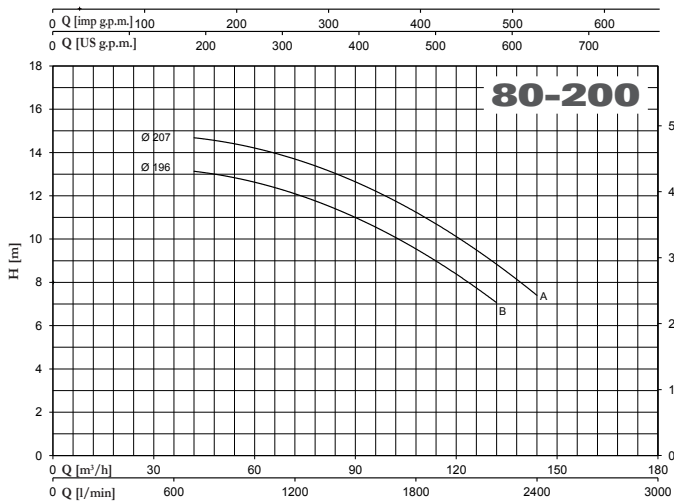
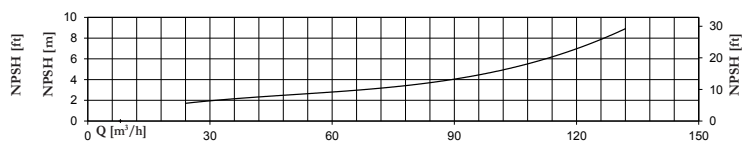
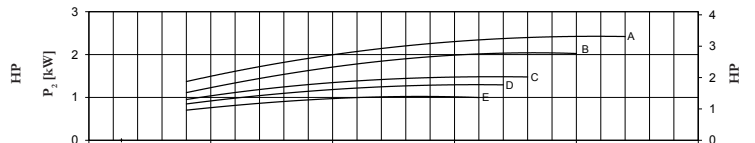
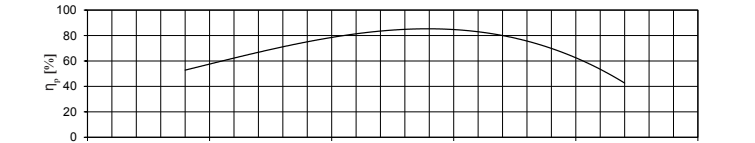
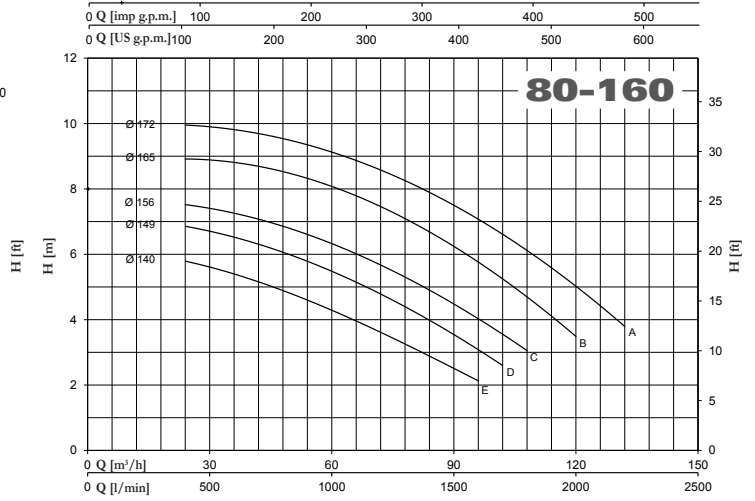
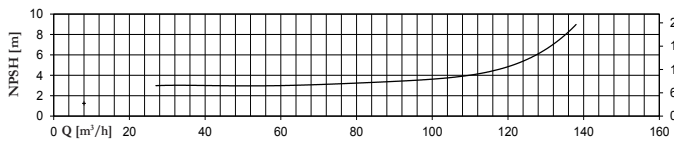
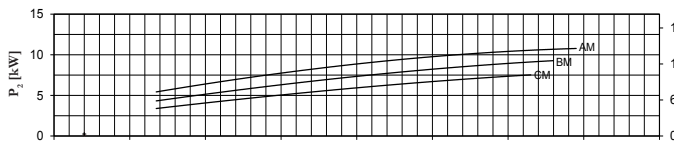
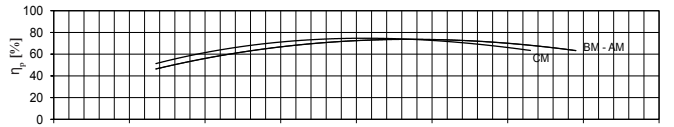

# 4CA/4CAT - 4CAX EN 733 ~ 1450 r.p.m.

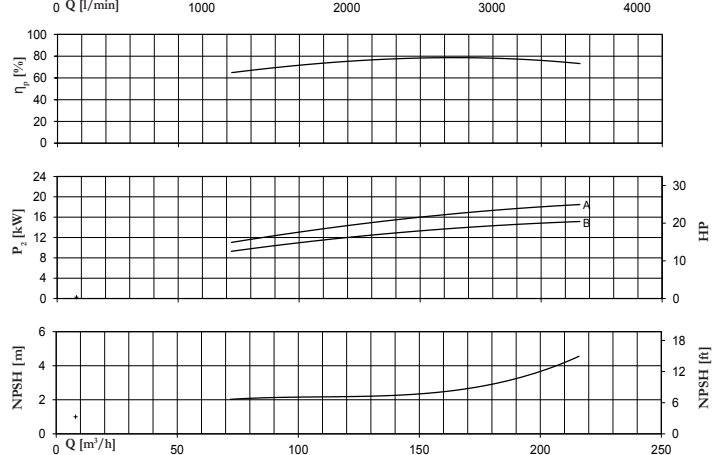
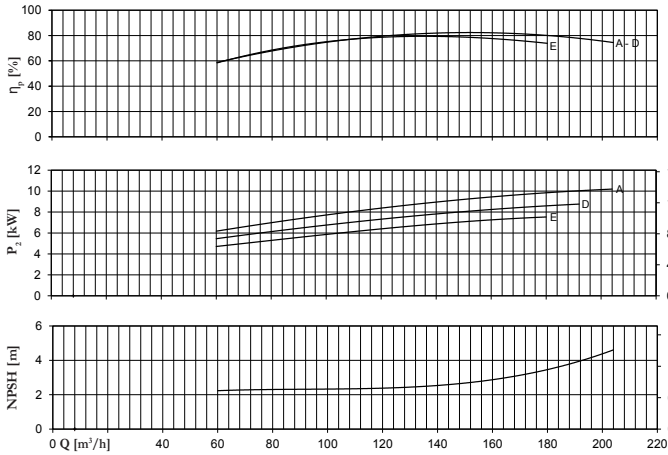
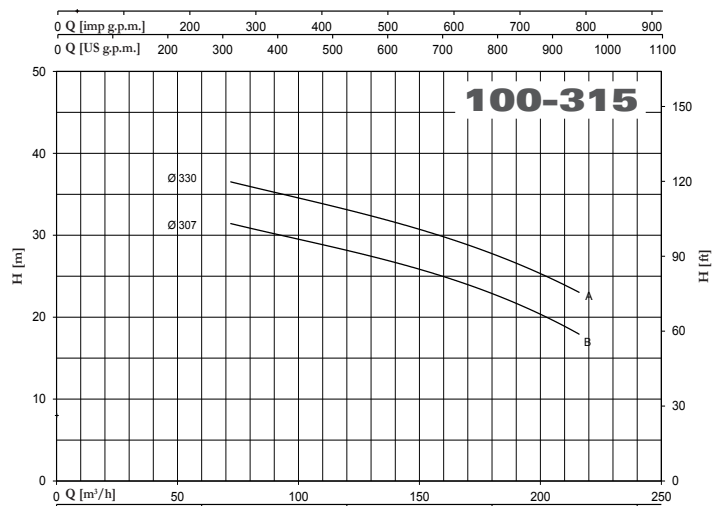
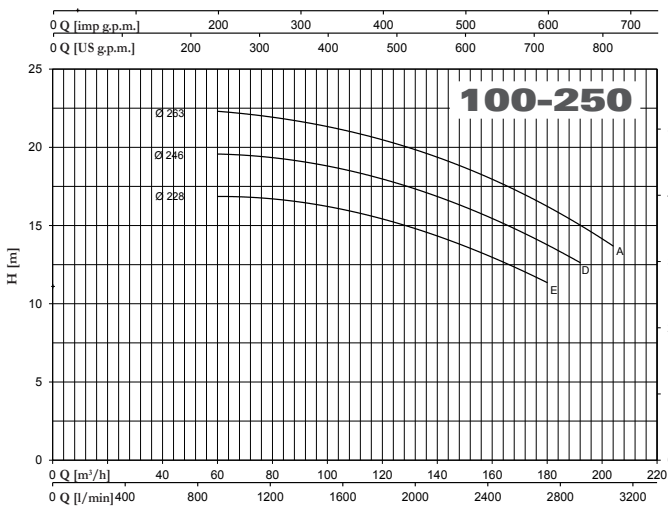
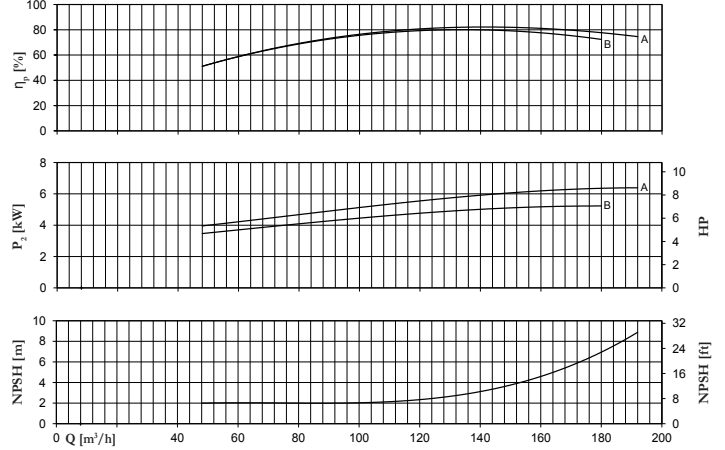
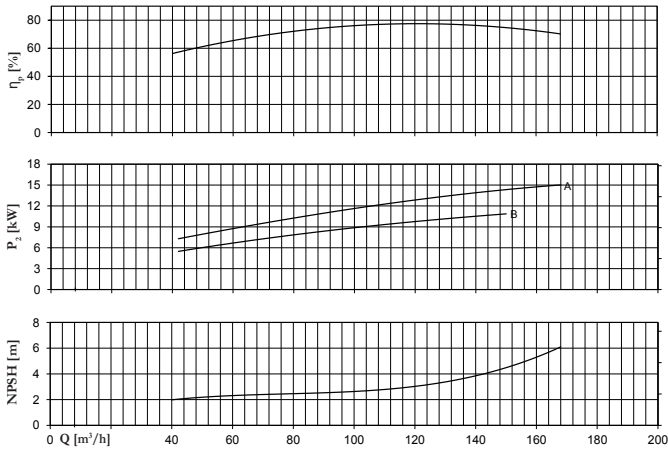
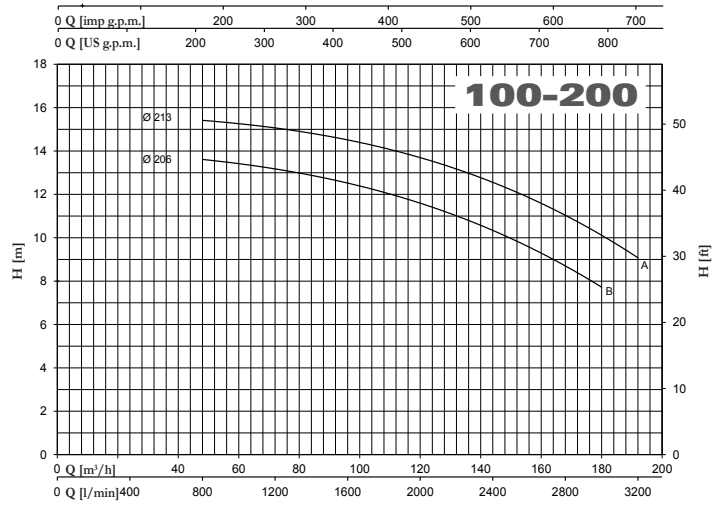
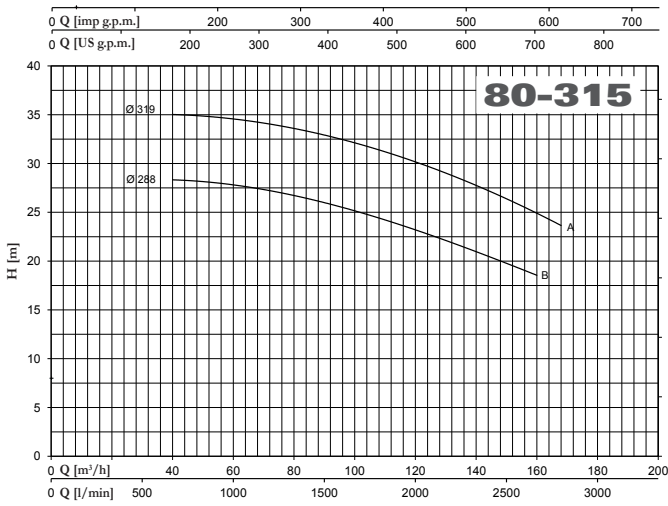

# 4CA/4CAT - 4CAX EN 733 ~ 1450 r.p.m.

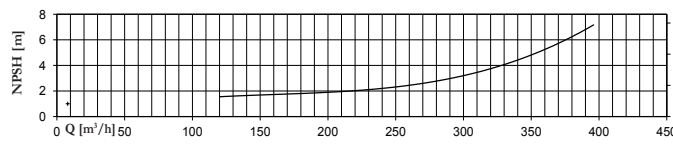
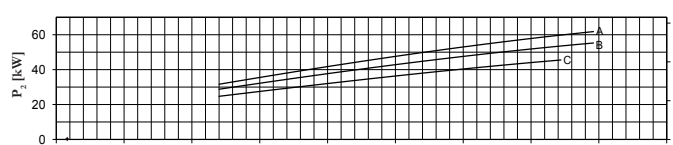
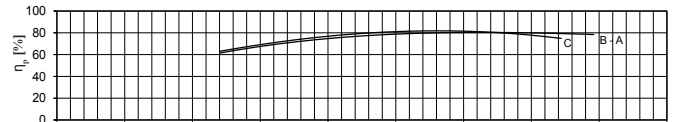
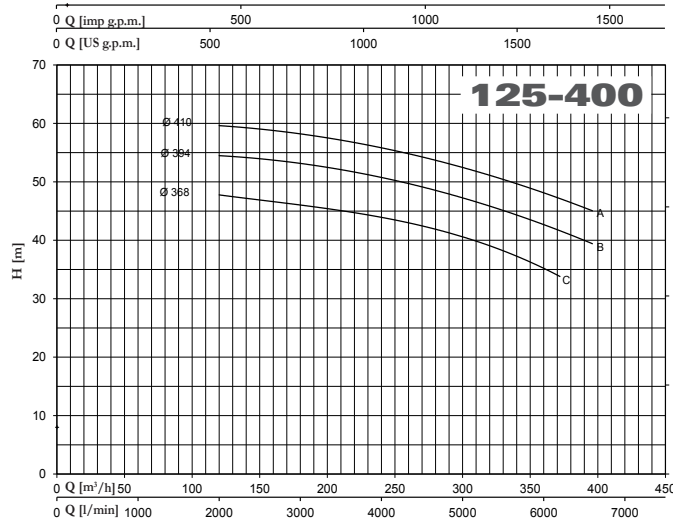
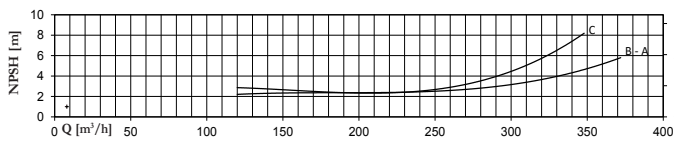
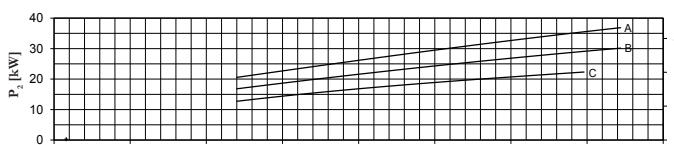
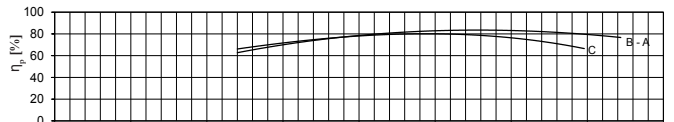
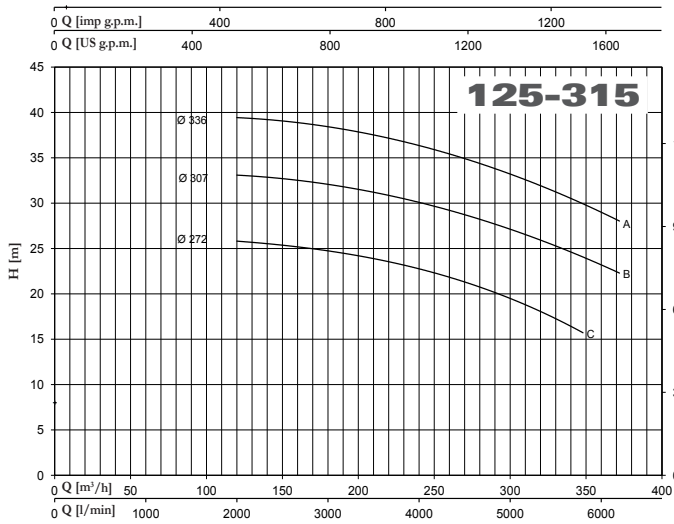
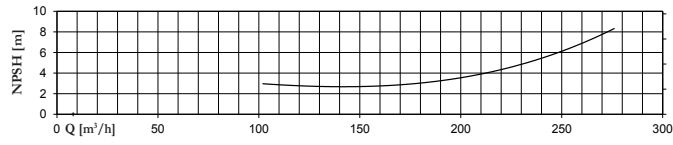
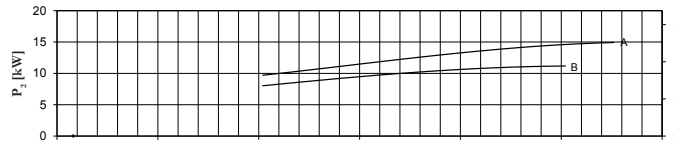
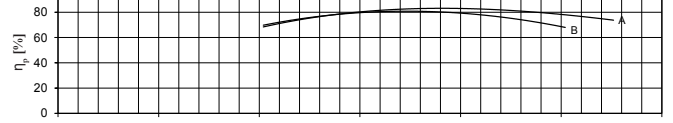
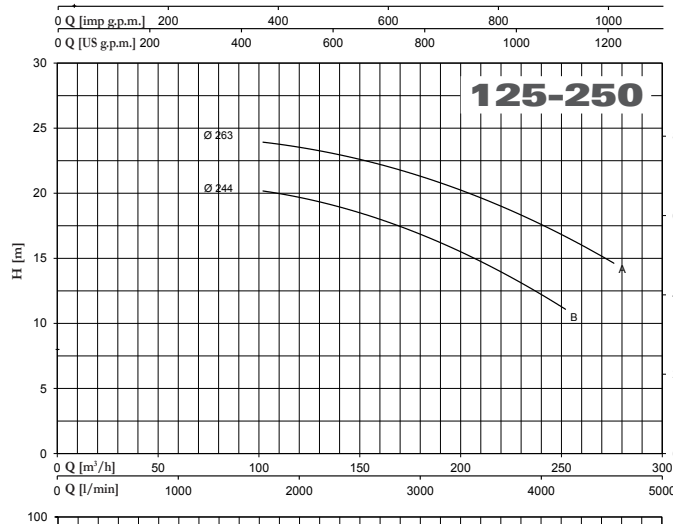
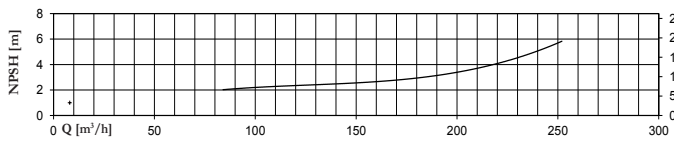
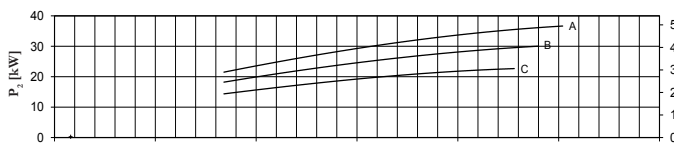
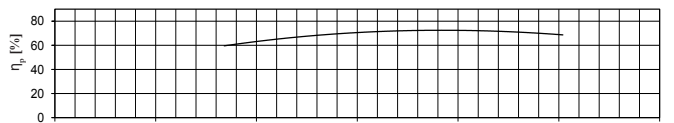
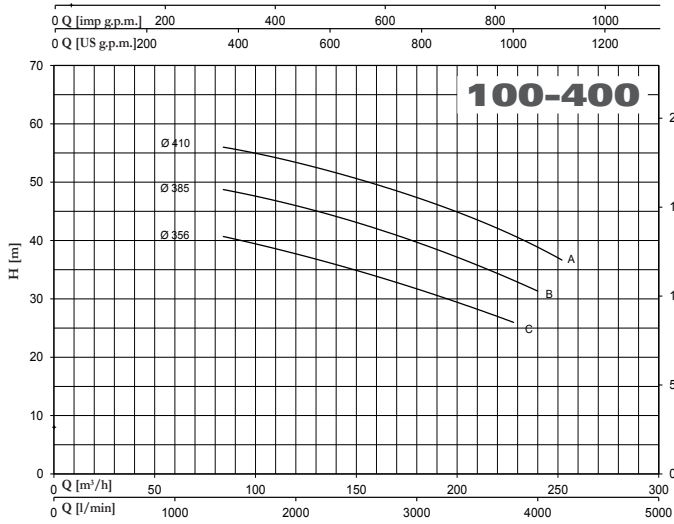

# 4CA/4CAT - 4CAX EN 733 ~ 1450 r.p.m.

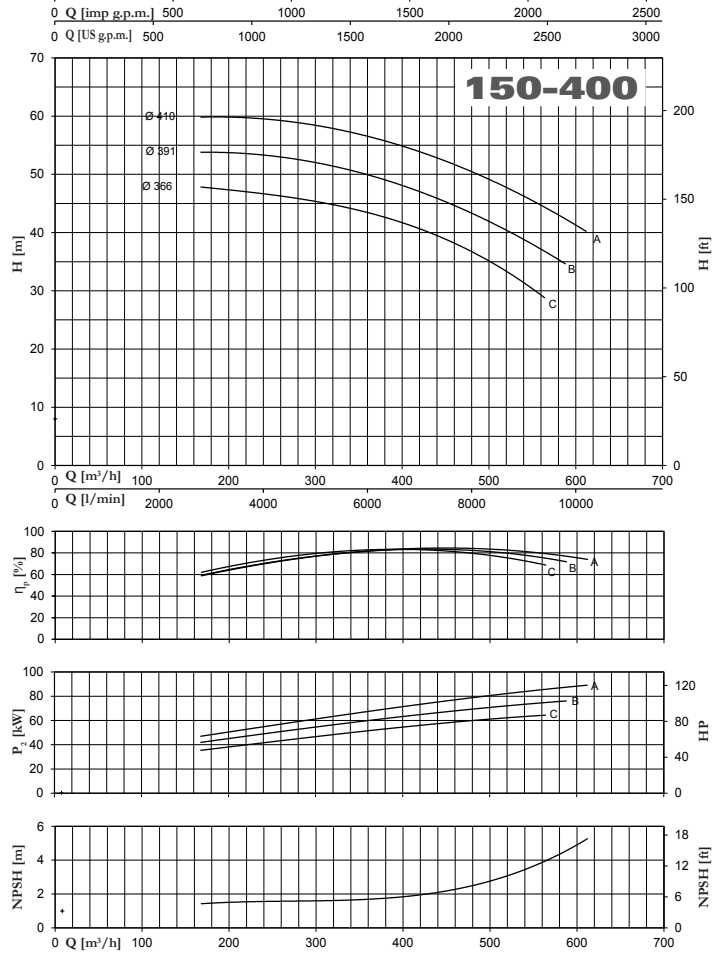
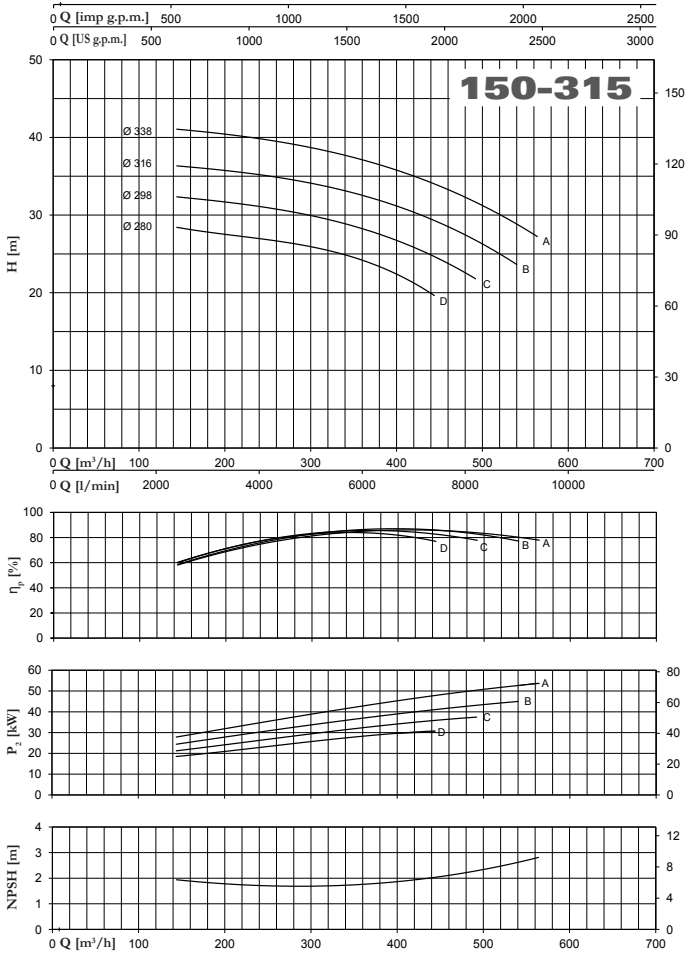

# 4CA - 4CAX (No EN 733) ~ 1450 r.p.m.

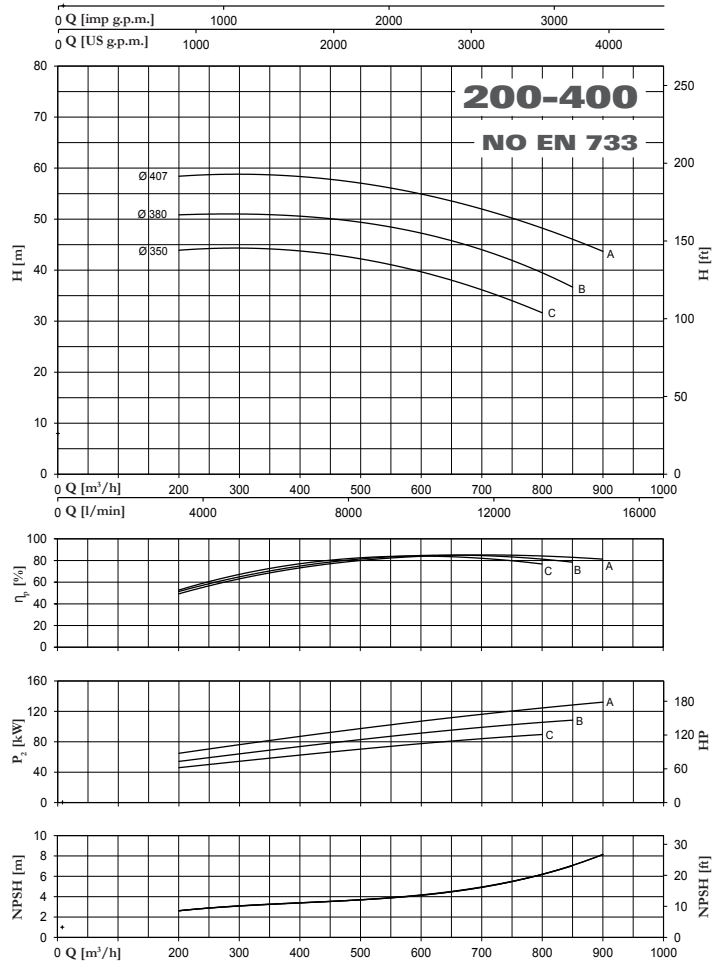
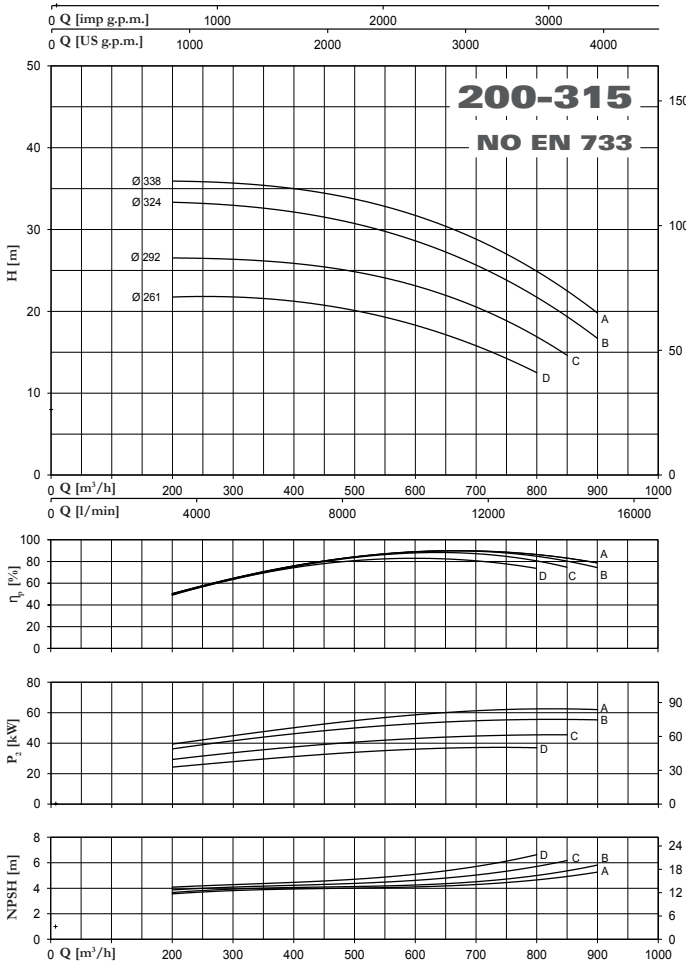



# 4CA - 4CAX (No EN 733) ~ 1450 r.p.m.

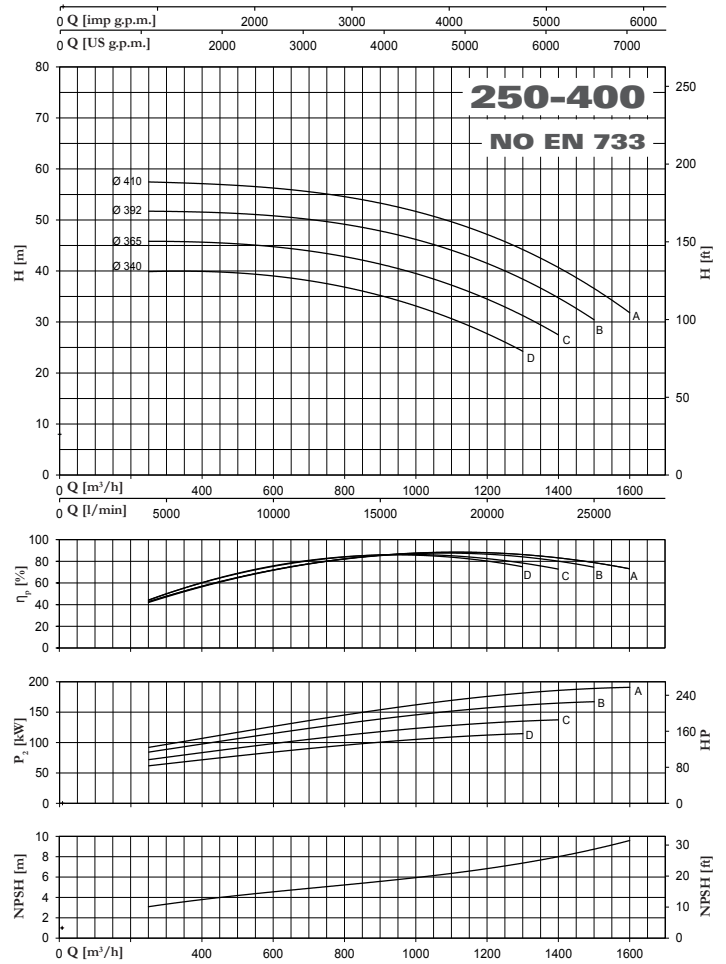
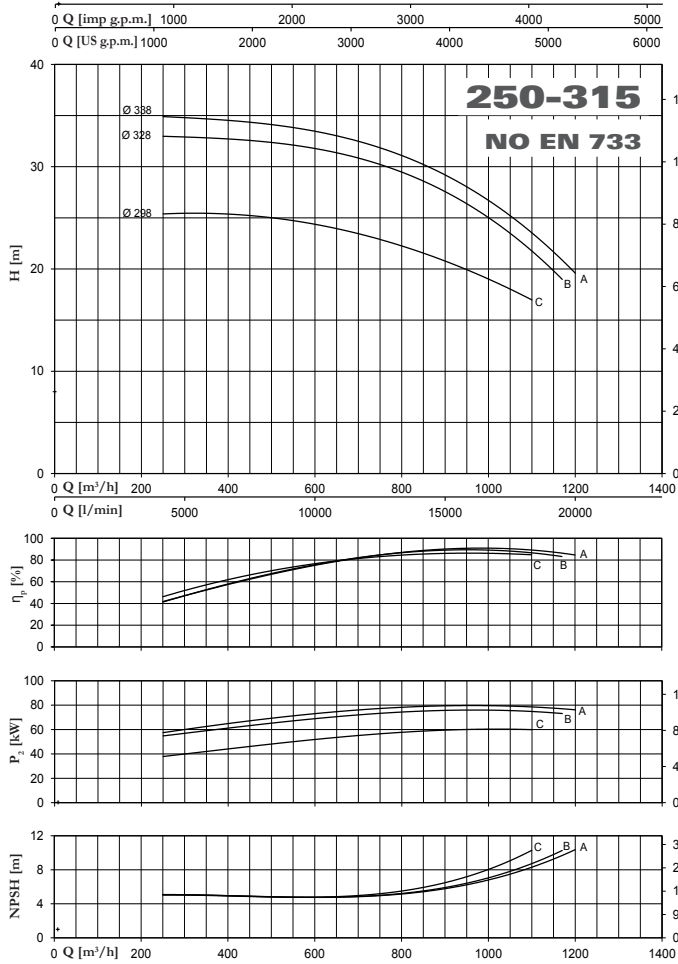

Tolerance: ISO 9906:2012 - Grade 3B



**CA/CAT - CAX EN 733 ~ 2900 r.p.m.**  
**4CA/4CAT - 4CAX EN 733 ~ 1450 r.p.m.**

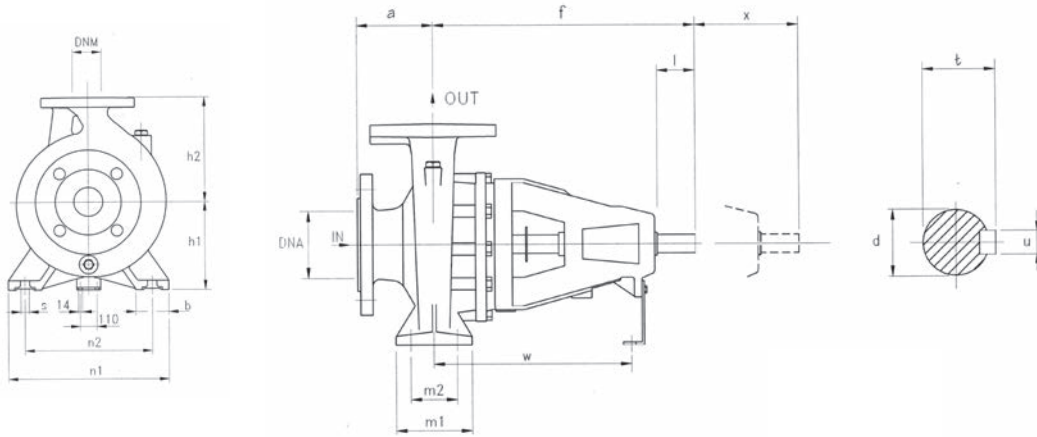

TYPE	DIMENSIONS (mm)																					
	DNA	DNM	a	f	h1	h2	m1	m2	n1	n2	s	b	l	d	t	u	x	w	I	L	M	Kg
32-160			80	360	132	160	100	70	240	190	14	50	50	24	27	8	100	260	535	320	445	38
32-200	50	32	80	360	160	180	100	70	240	190	14	50	50	24	27	8	100	260	535	320	445	41
32-250			100	360	180	225	125	95	320	250	14	65	65	24	27	8	100	260	545	405	545	49
40-125			80	360	112	140	100	70	210	160	14	50	50	24	27	8	100	260	535	320	445	37
40-160			80	360	132	160	100	70	240	190	14	50	50	24	27	8	100	260	535	320	445	40
40-200			100	360	160	180	100	70	265	212	14	50	50	24	27	8	100	260	535	320	445	44
40-250			100	360	180	225	125	95	320	250	14	65	50	24	27	8	100	260	545	405	545	49,5
50-125			100	360	132	160	100	70	240	190	14	50	50	24	27	8	100	260	535	320	445	39,5
50-160			100	360	160	180	100	70	265	212	14	50	50	24	27	8	100	260	535	320	445	44
50-200			100	360	160	200	100	70	265	212	14	50	50	24	27	8	100	260	535	320	445	47
50-250			100	360	180	225	125	95	320	250	14	65	50	24	27	8	100	260	545	405	545	53
50-315	80		125	470	225	280	125	95	345	280	14	65	80	32	35,3	10	100	340	655	465	620	94,5
65-125			100	360	160	180	125	95	280	212	14	65	65	24	27	8	100	260	535	320	445	44,5
65-160			100	360	160	200	125	95	280	212	14	65	65	24	27	8	100	260	535	320	445	49
65-200			100	360	180	225	125	95	320	250	14	65	65	24	27	8	140	260	545	405	545	54
65-250			100	470	200	250	160	120	360	280	19	80	80	32	35	10	140	340	545	405	545	76,5
65-315			125	470	225	280	160	120	400	315	19	80	80	32	35	10	140	340	655	465	620	96
80-160			125	360	180	225	125	95	320	250	14	65	50	24	27	8	140	260	545	405	545	58
80-200			125	470	180	250	125	95	345	280	14	65	80	32	35	10	140	340	680	405	545	74
80-250			125	470	200	280	160	120	400	315	18	80	80	32	35,3	10	140	340	655	465	585	91
80-315			125	470	250	315	160	120	400	315	18	80	80	32	35,3	10	140	340	655	465	620	106
100-200			125	470	200	280	160	120	360	286	18	80	80	32	35,3	10	140	340	655	465	620	95
100-250			140	470	225	280	160	120	400	315	18	80	80	32	35,3	10	140	340	655	465	620	103
100-315			140	470	250	315	160	120	400	315	18	80	80	32	35,3	10	140	340	655	465	620	122
100-400			140	530	280	355	200	150	500	400	22	100	110	42	45,3	12	140	370	720	775	855	183,5
125-250			160	530	315	450	200	150	400	315	22	100	110	32	45,3	12	140	370	655	465	620	132
125-315			140	530	280	355	200	150	500	400	22	100	110	42	45,3	12	140	370	720	775	855	176
125-400			140	530	315	400	200	150	500	400	22	100	110	42	45,3	12	140	370	720	775	855	198
150-315			160	530	280	400	200	150	550	450	22	100	110	42	45,3	12	140	370	655	465	620	191
150-400			160	530	315	450	200	150	550	450	22	100	110	42	45,3	12	140	370	720	775	855	218,5
200-315			180	706	355	450	250	190	634	500	28	134	110	55	58,3	16	208	523	800	1200	1150	345
200-400			180	706	355	500	250	190	634	500	28	134	110	55	58,3	16	214	523	800	1200	1150	346
250-315			225	711	400	500	250	200	694	560	28	134	110	55	58,3	16	214	528	800	1200	1070	401,5
250-400			225	706	400	550	250	200	694	560	28	134	110	55	58,3	16	220	523	800	1200	1120	393

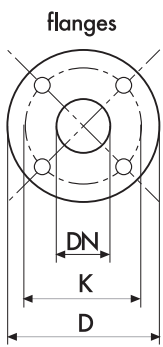

DN	D	K	holes	
			n°	Ø
32	140	100	4	18
40	150	110	4	18
50	165	125	4	18
65	185	145	4	18
80	200	160	8	18
100	220	180	8	18
125	250	210	8	18
150	285	240	8	23
200	340	295	8	23
250	395	350	12	23
300	445	400	12	23



# CA/CAT - CAX EN 733 ~ 2900 r.p.m.

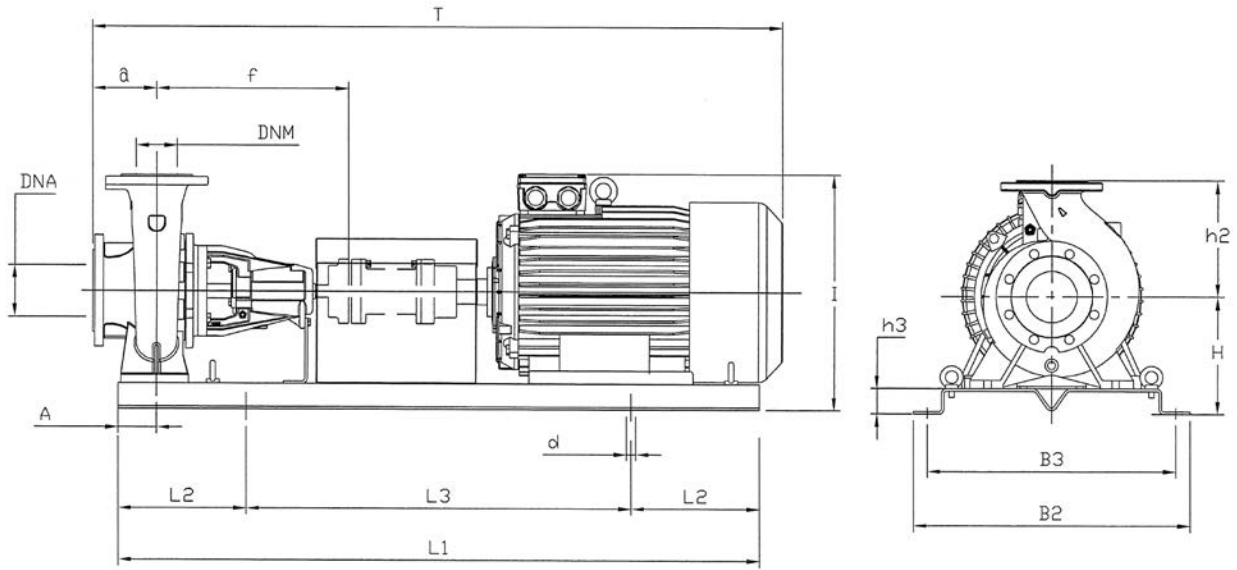

TYPE	kW	Motor Size	DIMENSIONS (mm)																Kg
			DNA	DNM	a	f	H	h2	h3	L1	L2	L3	B2	B3	A	d	T	I	
32-160C	1,5	90S	50	32	80	360	182	160	50	800	130	540	360	320	60	18	855	342	82,1
32-160B	2,2	90L	50	32	80	360	182	160	50	900	150	600	390	350	60	18	920	342	87,7
32-160A	3	100L	50	32	80	360	182	160	50	900	150	600	390	350	60	18	920	362	96,7
32-160A	4	112M	50	32	80	360	182	160	50	900	150	600	390	350	60	18	940	375	104,7
32-200C	4	112M	50	32	80	360	210	180	50	900	150	600	390	350	60	18	940	403	108,7
32-200B	5,5	132S	50	32	80	360	210	180	50	1000	170	660	450	400	60	22	1020	433	116,1
32-200A	7,5	132S	50	32	80	360	210	180	50	1000	170	660	450	400	60	22	1020	433	144,3
32-250C	11	160M	50	32	100	360	230	225	50	1250	205	840	540	490	75	22	1275	495	207,3
32-250B	11	160M	50	32	100	360	230	225	50	1250	205	840	540	490	75	22	1275	495	207,3
32-250A	15	160M	50	32	100	360	230	225	50	1250	205	840	540	490	75	22	1275	495	219,3
40-125C	1,5	90S	65	40	80	360	162	140	50	800	130	540	360	320	60	18	855	317	82,2
40-125C	2,2	90L	65	40	80	360	162	140	50	900	150	600	390	350	60	18	920	317	87,8
40-125B	2,2	90L	65	40	80	360	162	140	50	900	150	600	390	350	60	18	920	317	87,8
40-125B	3	100L	65	40	80	360	162	140	50	900	150	600	390	350	60	18	920	342	96,8
40-125A	3	100L	65	40	80	360	162	140	50	900	150	600	390	350	60	18	920	342	96,8
40-160B	3	100L	65	40	80	360	182	160	50	900	150	600	390	350	60	18	920	362	99,8
40-160B	4	112M	65	40	80	360	182	160	50	900	150	600	390	350	60	18	940	375	107,8
40-160A	4	112M	65	40	80	360	182	160	50	900	150	600	390	350	60	18	940	375	107,8
40-160A	5,5	132S	65	40	80	360	182	160	50	1000	170	660	450	400	60	22	1020	405	115,2
40-160AP	5,5	132S	65	40	80	360	182	160	50	1000	170	660	450	400	60	22	1020	405	115,2
40-200B	5,5	132S	65	40	100	360	210	180	50	1000	170	660	450	400	60	22	1040	433	119,2
40-200B	7,5	132S	65	40	100	360	210	180	50	1000	170	660	450	400	60	22	1040	433	147,4
40-200A	7,5	132S	65	40	100	360	210	180	50	1000	170	660	450	400	60	22	1040	433	147,4
40-200A	11	160M	65	40	100	360	210	180	50	1120	190	740	490	440	60	22	1168	475	198,4
40-200 AP	7,5	132S	65	40	100	360	210	180	50	1000	170	660	450	400	60	22	1040	433	147,4
40-200 AP	11	160M	65	40	100	360	210	180	50	1120	190	740	490	440	60	22	1168	475	198,4
40-250C	11	160M	65	40	100	360	230	225	50	1250	205	840	540	490	75	22	1275	495	208,9
40-250B	11	160M	65	40	100	360	230	225	50	1250	205	840	540	490	75	22	1275	495	208,9
40-250B	15	160M	65	40	100	360	230	225	50	1250	205	840	540	490	75	22	1275	495	220,9
40-250A	15	160M	65	40	100	360	230	225	50	1250	205	840	540	490	75	22	1275	495	220,9
40-250A	18,5	160L	65	40	100	360	230	225	50	1250	205	840	540	490	75	22	1275	495	238,9
40-250BM	18,5	160L	65	40	100	360	230	225	50	1250	205	840	540	490	75	22	1275	495	238,9
40-250AM	22	180M	65	40	100	360	230	225	50	1250	205	840	540	490	75	22	1275	510	297,3



# CA/CAT - CAX EN 733 ~ 2900 r.p.m.

TYPE	kW	Motor Size	DIMENSIONS (mm)																	Kg
			DNA	DNM	a	f	H	h2	h3	L1	L2	L3	B2	B3	A	d	T	I		
50-125B	3	100L	65	50	100	360	182	160	50	900	150	600	390	350	60	18	940	362	99,7	
50-125A	4	112M	65	50	100	360	182	160	50	900	150	600	390	350	60	18	960	375	107,7	
50-160B	5,5	132S	65	50	100	360	210	180	50	1000	170	660	450	400	60	22	1040	433	119,6	
50-160A	7,5	132S	65	50	100	360	210	180	50	1000	170	660	450	400	60	22	1040	433	147,8	
50-200C	11	160M	65	50	100	360	210	200	50	1120	190	740	490	440	60	22	1168	475	201,8	
50-200B	11	160M	65	50	100	360	210	200	50	1120	190	740	490	440	60	22	1168	475	201,8	
50-200A	15	160M	65	50	100	360	210	200	50	1120	190	740	490	440	60	22	1168	475	213,8	
50-250C	15	160M	65	50	100	360	230	225	50	1250	205	840	540	490	75	22	1275	495	224,8	
50-250B	18,5	160L	65	50	100	360	230	225	50	1250	205	840	540	490	75	22	1275	495	242,8	
50-250A	22	180M	65	50	100	360	230	225	50	1250	205	840	540	490	75	22	1275	510	301,2	
50-315DN	37	200L	80	50	125	470	275	280	50	1400	230	940	610	550	75	26	1455	585	415,0	
50-315CN	45	225M	80	50	125	470	275	280	50	1400	230	940	610	550	75	26	1500	605	465,8	
50-315BN	55	250M	80	50	125	470	310	280	85	1600	270	1060	660	600	75	26	1650	710	611,8	
50-315AN	75	280S	80	50	125	470	310	280	85	1800	300	1200	730	670	75	26	1850	770	762,6	
65-125B	5,5	132S	80	65	100	360	210	180	50	1000	170	660	450	400	60	22	1040	433	121,4	
65-125A	7,5	132S	80	65	100	360	210	180	50	1000	170	660	450	400	60	22	1040	433	149,6	
65-160C	11	160M	80	65	100	360	210	200	50	1120	190	740	490	440	60	22	1168	475	205,1	
65-160B	11	160M	80	65	100	360	210	200	50	1120	190	740	490	440	60	22	1168	475	205,1	
65-160A	15	160M	80	65	100	360	210	200	50	1120	190	740	490	440	60	22	1168	475	217,1	
65-200C	15	160M	80	65	100	360	230	225	50	1250	205	840	540	490	75	22	1275	495	227,5	
65-200B	18,5	160L	80	65	100	360	230	225	50	1250	205	840	540	490	75	22	1275	495	245,5	
65-200A	22	180M	80	65	100	360	230	225	50	1250	205	840	540	490	75	22	1290	510	303,3	
65-250B	30	200L	80	65	100	470	250	250	50	1400	230	940	610	550	90	26	1470	560	377,8	
65-250A	37	200L	80	65	100	470	250	250	50	1400	230	940	610	550	90	26	1470	560	397,8	
65-315CN	55	250M	80	65	125	470	310	280	85	1600	270	1060	660	600	90	26	1645	710	614,2	
65-315BN	75	280S	80	65	125	470	310	280	85	1800	300	1200	730	670	90	26	1835	770	765,0	
65-315AN	90	280M	80	65	125	470	310	280	85	1800	300	1200	730	670	90	26	1835	770	839,2	
80-160E	11	160M	100	80	125	360	230	225	50	1250	205	840	540	490	75	22	1300	495	220,8	
80-160D	11	160M	100	80	125	360	230	225	50	1250	205	840	540	490	75	22	1300	495	220,8	
80-160C	15	160M	100	80	125	360	230	225	50	1250	205	840	540	490	75	22	1300	495	232,8	
80-160B	18,5	160L	100	80	125	360	230	225	50	1250	205	840	540	490	75	22	1300	495	250,8	
80-160A	22	180M	100	80	125	360	230	225	50	1250	205	840	540	490	75	22	1315	510	308,7	
80-200B	30	200L	100	80	125	470	230	250	50	1400	230	940	610	550	75	26	1495	560	376,7	
80-200A	37	200L	100	80	125	470	230	250	50	1400	230	940	610	550	75	26	1495	560	396,7	
80-250B	45	225M	100	80	125	470	250	280	50	1400	230	940	610	550	90	26	1540	605	464,5	
80-250A	55	250M	100	80	125	470	285	280	85	1600	270	1060	660	600	90	26	1645	710	610,5	
80-315BN	90	280M	100	80	125	470	335	315	85	1800	300	1200	730	670	90	26	1835	770	850,5	
80-315AN	110	315S	100	80	125	470	NA	315	NA	NA	NA	NA	NA	NA	90	NA	NA	NA	NA	
100-200B	45	225M	125	100	125	470	250	280	50	1400	230	940	610	550	90	26	1540	605	471,5	
100-200A	55	250M	125	100	125	470	285	280	85	1600	270	1060	660	600	90	26	1645	710	617,5	
100-250C	55	250M	125	100	140	470	310	280	85	1600	270	1060	660	600	90	26	1660	710	625,5	
100-250C	75	280S	125	100	140	470	310	280	85	1800	300	1200	730	670	90	26	1850	770	776,3	
100-250B	75	280S	125	100	140	470	310	280	85	1800	300	1200	730	670	90	26	1850	770	776,3	
100-250A	90	280M	125	100	140	470	310	280	85	1800	300	1200	730	670	90	26	1850	770	850,5	



# 4CA/4CAT - 4CAX EN 733 ~ 1450 r.p.m.

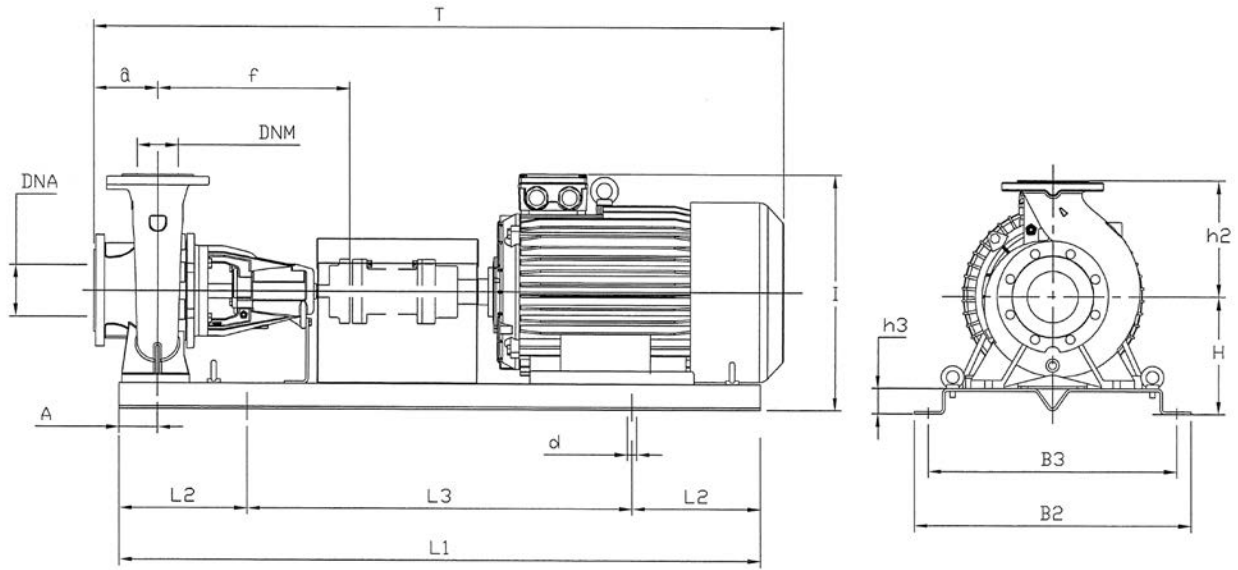

TYPE	kW	Motor Size	DIMENSIONS (mm)																	Kg
			DNA	DNM	a	f	H	h2	h3	L1	L2	L3	B2	B3	A	d	T	I		
32-160C	0,37	71M	50	32	80	360	182	160	50	800	130	540	360	320	60	18	820	342	59,4	
32-160B	0,37	71M	50	32	80	360	182	160	50	800	130	540	360	320	60	18	820	342	59,4	
32-160A	0,55	80M	50	32	80	360	182	160	50	800	130	540	360	320	60	18	820	342	59,1	
32-200C	0,75	80M	50	32	80	360	210	180	50	800	130	540	360	320	60	18	820	390	75,1	
32-200B	1,1	90S	50	32	80	360	210	180	50	800	130	540	360	320	60	18	855	390	88,1	
32-200A	1,1	90S	50	32	80	360	210	180	50	800	130	540	360	320	60	18	855	390	88,1	
32-250C	1,5	90S	50	32	100	360	230	225	50	1000	170	660	450	400	75	22	1025	455	106,7	
32-250B	1,5	90S	50	32	100	360	230	225	50	1000	170	660	450	400	75	22	1025	455	106,7	
32-250A	2,2	100L	50	32	100	360	230	225	50	1000	170	660	450	400	75	22	1025	455	112,7	
40-125C	0,37	71M	65	40	80	360	162	140	50	800	130	540	360	320	60	18	820	302	59,5	
40-125B	0,37	71M	65	40	80	360	162	140	50	800	130	540	360	320	60	18	820	302	59,5	
40-125A	0,55	80M	65	40	80	360	162	140	50	800	130	540	360	320	60	18	820	307	59,2	
40-160B	0,55	80M	65	40	80	360	182	160	50	800	130	540	360	320	60	18	820	342	62,2	
40-160A	0,75	80M	65	40	80	360	182	160	50	800	130	540	360	320	60	18	820	342	74,2	
40-160AP	0,75	80M	65	40	80	360	182	160	50	800	130	540	360	320	60	18	820	342	74,2	
40-160AP	1,1	90S	65	40	80	360	182	160	50	800	130	540	360	320	60	18	855	342	87,2	
40-200B	1,1	90S	65	40	100	360	210	180	50	900	150	600	390	350	60	18	940	390	93,8	
40-200A	1,1	90S	65	40	100	360	210	180	50	900	150	600	390	350	60	18	940	390	93,8	
40-200A	1,5	90S	65	40	100	360	210	180	50	900	150	600	390	350	60	18	940	390	98,8	
40-200AP	1,1	90S	65	40	100	360	210	180	50	900	150	600	390	350	60	18	940	390	93,8	
40-200AP	1,5	90S	65	40	100	360	210	180	50	900	150	600	390	350	60	18	940	390	98,8	
40-250C	1,5	90S	65	40	100	360	230	225	50	1000	170	660	450	400	75	22	1025	455	108,3	
40-250B	2,2	100L	65	40	100	360	230	225	50	1000	170	660	450	400	75	22	1025	455	114,3	
40-250A	2,2	100L	65	40	100	360	230	225	50	1000	170	660	450	400	75	22	1025	455	114,3	



