

# ULTRA SLG/SLXG

Multistage Vertical

Stainless steel multistage vertical pumps. For non-loaded clean fluids, pressurizing system, irrigation, drinking and glycol water, water treatment, food industry, heating and air conditioning, washing system.



ULTRA 3-5-7-9 SLG



ULTRA 3-5-7 SLXG



ULTRA 9 SLXG



## Construction features

<b>Pump body</b>	cast iron (SLG); stainless steel AISI 304 (SLXG)
<b>Motor bracket</b>	cast iron
<b>Impellers, diffusers, shell, motor shaft</b>	stainless steel AISI 304
<b>Mechanical seal</b>	ceramic-graphite-EPDM graphite-silicon carbide-EPDM
<b>Intermediate shaft guiding stage bush</b>	ceramic-tungsten carbide
<b>Ambient temperature</b>	max 40 °C
<b>Liquid temperature</b>	-15 ÷ +110 °C
<b>Max operating pressure</b>	max 25 bar
<b>Pump body gasket</b>	EPDM

## Motor

<b>2 pole induction motor</b>	3- 230/400V-50Hz P ≤ 4kW 3- 400/690V-50Hz P > 4kW
<b>Insulation class</b>	F
<b>Protection degree</b>	IPX5



MODEL	LOTS			
	TRUCK		CONTAINER	
	PALLET (cm)	N° pumps	PALLET (cm)	N° pumps
U 3SLG/SLXG-350/14 T-380/16 T	100×120×150	12	100×120×150	12
U 3SLG/SLXG-400/18 T-450/20 T	100×135×150	12	100×135×150	12
U 5SLG/SLXG-400/14 T-450/16 T	100×120×150	12	100×120×150	12
U 5SLG/SLXG-550/18 T-600/20 T	100×135×150	12	100×135×150	12
U 7SLG/SLXG-750/12 T-800/14 T	100×120×150	12	100×120×150	12
U 7SLG/SLXG-900/16 T-1000/20 T	100×135×150	12	100×135×150	12
U 9SLG/SLXG-750/12 T-800/14 T	100×120×150	12	100×120×150	12
U 9SLG/SLXG-900/16 T-1000/20 T	100×135×150	12	100×135×150	12

## U 3 S V/ X/ G - 350/14 T

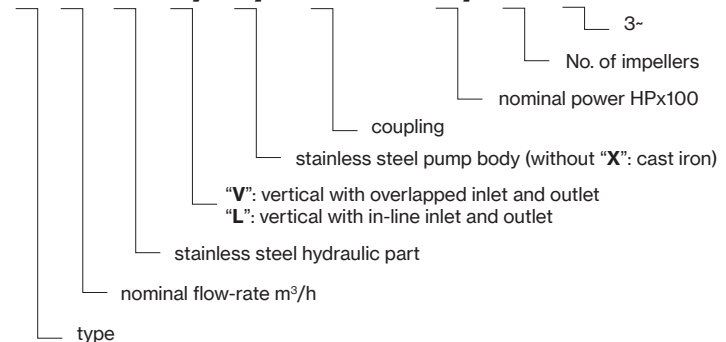

# ULTRA SLG/SLXG

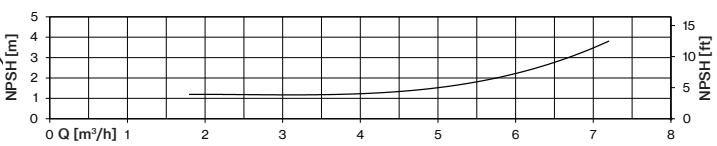
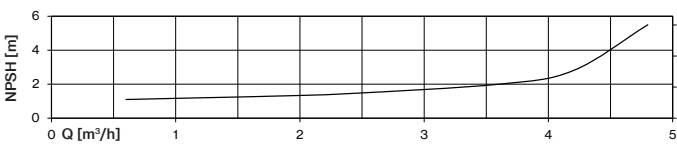
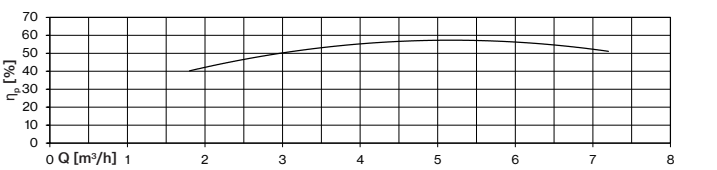
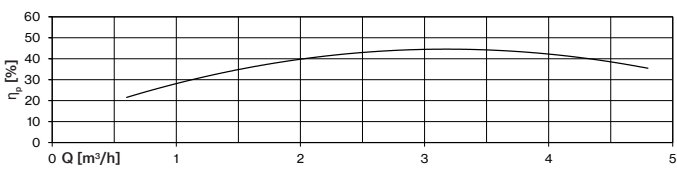
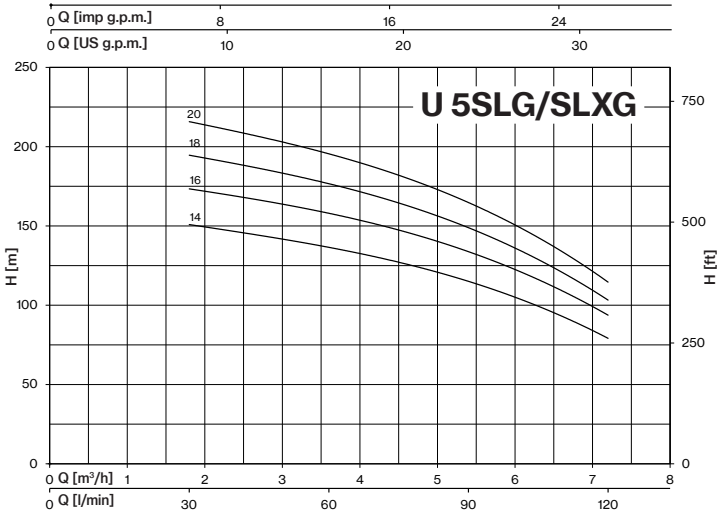
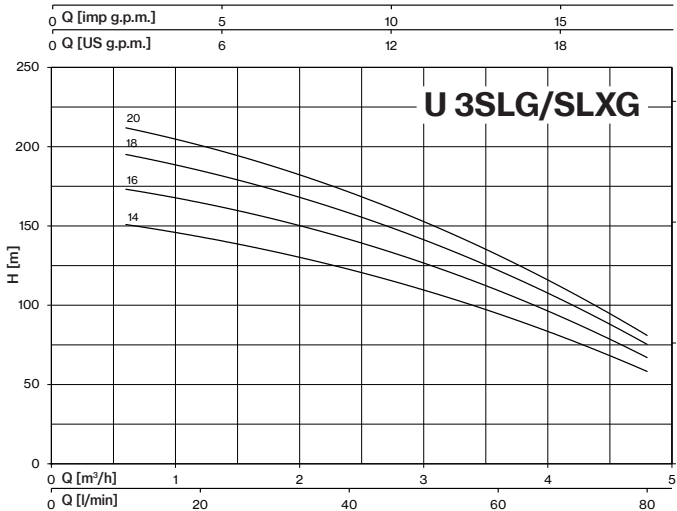

TYPE	P2		P1 (kW)	AMPERE 3~	Q (m³/h - l/min)						
					0 0,6 1,2 1,8 2,4 3,6 4,8						
					0 10 20 30 40 60 80						
3~	HP	kW	3~	3x400 V 50 Hz	H (m)						
					U 3...-350/14 T	3	2,2	2,5	4,7	154,8	150,9
U 3...-380/16 T	4	3	2,9	5,5	177,5	173,2	164,6	154,5	141,3	109,4	67,0
U 3...-400/18 T	4	3	3,2	6,0	200,3	195,1	184,9	172,8	158,0	122,1	75,3
U 3...-450/20 T	4	3	3,6	6,5	218,3	211,9	200,6	187,4	171,4	131,5	81,0

TYPE	P2		P1 (kW)	AMPERE 3~	Q (m³/h - l/min)						
					0 1,8 2,4 3,6 4,8 6 7,2						
					0 30 40 60 80 100 120						
3~	HP	kW	3~	3x400 V 50 Hz	H (m)						
					U 5...400/14T	4	3	3,5	6,3	159,2	150,7
U 5...450/16T	5,5	4	4,1	7,9	182,0	173,2	169,1	158,0	142,9	122,9	93,6
U 5...550/18T	5,5	4	4,5	8,3	204,4	194,4	189,5	176,5	159,6	136,3	103,2
U 5...600/20T	5,5	4	5,0	8,9	226,7	215,5	210,0	195,5	176,3	151,1	114,5



# ULTRA SLG/SLXG

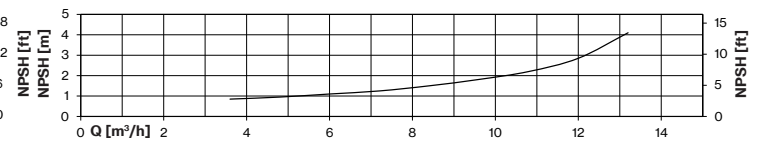
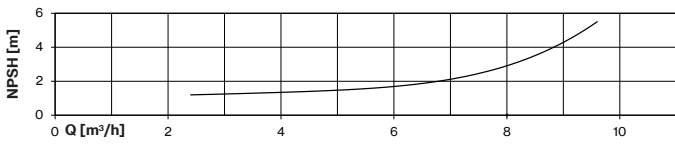
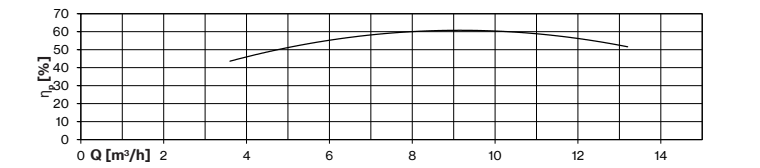
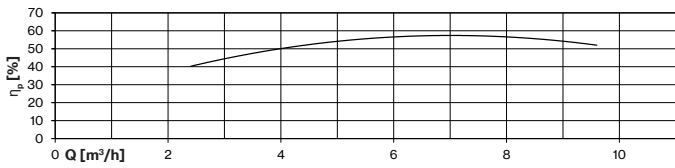
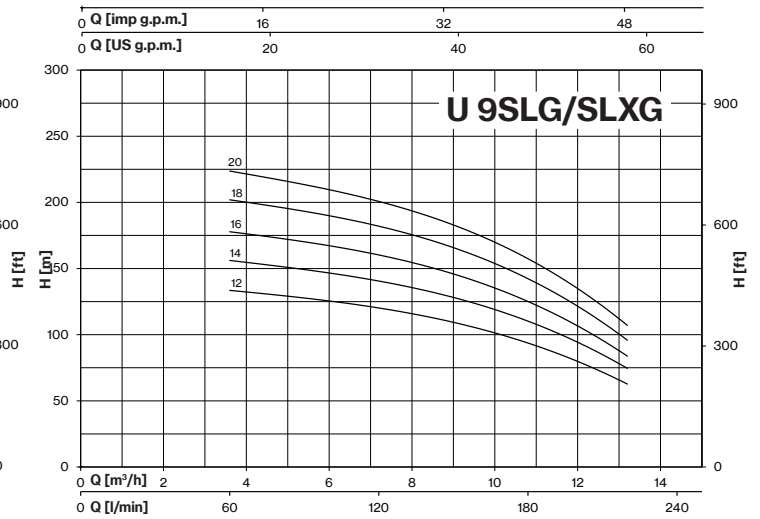
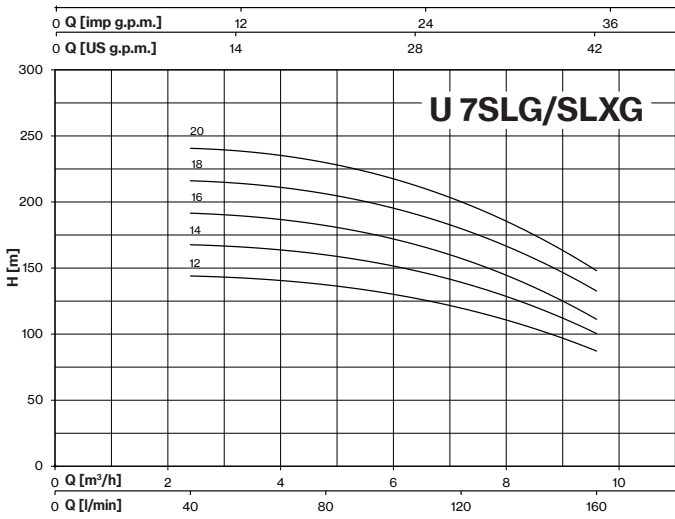

TYPE	P2		P1 (kW)	A	Q (m³/h - l/min)							
					3~							
					0	2,4	3,6	4,8	6	7,2	9,6	
3~	HP	kW	3~	3x400V 50Hz	0	40	60	80	100	120	160	
	H (m)											
U 7...750/12T	7,5	5,5	5,1	9,9	143,7	143,7	142,6	137,0	129,6	119,8	87,0	
U 7...800/14T	7,5	5,5	5,9	10,9	167,6	167,3	165,9	159,6	151,0	139,5	100,3	
U 7...900/16T	7,5	5,5	6,7	12,0	191,5	191,2	189,3	181,7	171,5	157,7	111,1	
U 7...950/18T	10	7,5	7,4	12,4	215,5	215,7	213,9	205,8	194,7	179,8	132,3	
U 7...1000/20T	10	7,5	8,2	13,5	240,3	240,2	238,4	229,3	216,8	200,3	147,7	

TYPE	P2		P1 (kW)	A	Q (m³/h - l/min)							
					3~							
					0	3,6	4,8	6	7,2	9,6	12	13,2
3~	HP	kW	3~	3x400V 50Hz	0	60	80	100	120	160	200	220
	H (m)											
U 9...750/12T	7,5	5,5	5,3	10,1	141,3	133,2	130,4	125,4	119,7	105,1	79,6	62,7
U 9...800/14T	7,5	5,5	6,1	11,1	165,5	155,7	152,6	146,5	139,9	123,4	94,0	74,6
U 9...900/16T	10	7,5	6,9	12,8	188,7	177,6	173,6	167,1	159,7	140,4	106,2	83,9
U 9...950/18T	10	7,5	7,6	12,7	213,8	201,6	197,3	189,6	181,2	159,9	121,0	96,0
U 9...1000/20T	10	7,5	8,5	13,9	236,7	223,1	218,3	209,3	199,8	176,1	134,5	107,0



### U 3-5-7 SLG/SLXG

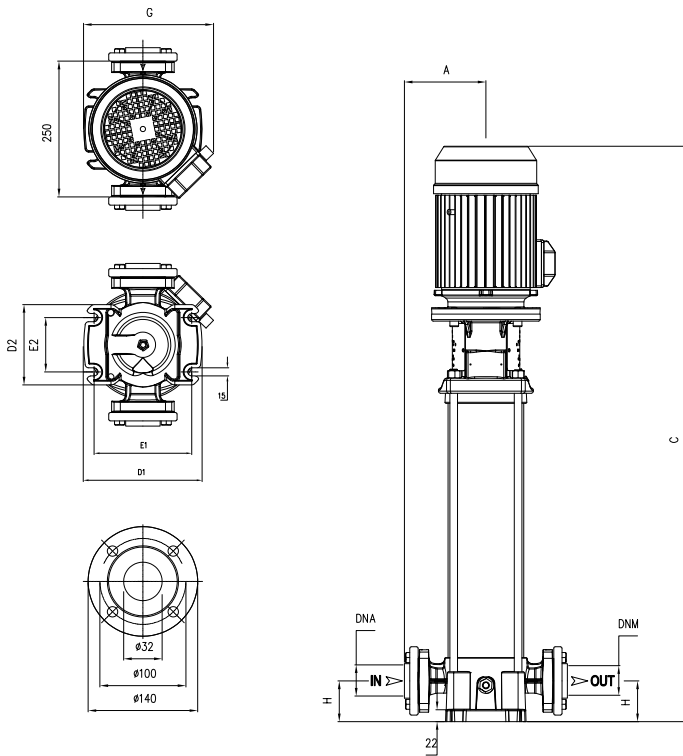

### U 9 SLG/SLXG

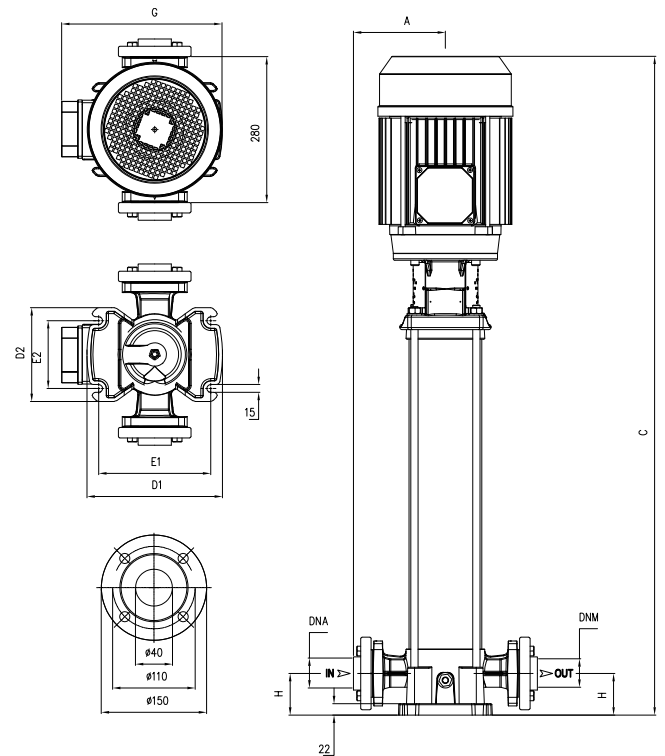

TYPE	DIMENSIONS (mm)										Kg	
	A	C	D1	D2	E1	E2	G	H	DNA	DNM	SLG	SLXG
U 3SLG-350/14T	155	932	220	150	180	100	236	75				49
U 3SLG-380/16T	155	977	220	150	180	100	236	75				53
U 3SLG-400/18T	155	1025	220	150	180	100	236	75	1" 1/4 G	1" 1/4 G		55
U 3SLG-450/20T	155	1098	220	150	180	100	251	75				63
U 3SLXG-350/14T	155	932	260	180	215	130	236	75				49
U 3SLXG-380/16T	155	977	260	180	215	130	236	75	1" 1/4 G	1" 1/4 G		53
U 3SLXG-400/18T	155	1025	260	180	215	130	236	75				55
U 3SLXG-450/20T	155	1098	260	180	215	130	251	75				62,5
U 5SLG-400/14 T	155	932	220	150	180	100	251	75				51,5
U 5SLG-450/16 T	155	1000	220	150	180	100	251	75	1" 1/4 G	1" 1/4 G		63,5
U 5SLG-550/18 T	155	1048	220	150	180	100	251	75				65,5
U 5SLG-600/20 T	155	1098	220	150	180	100	260	75				67
U 5SLXG-400/14 T	155	932	260	180	215	130	251	75				51,5
U 5SLXG-450/16 T	155	1000	260	180	215	130	251	75	1" 1/4 G	1" 1/4 G		63,5
U 5SLXG-550/18 T	155	1048	260	180	215	130	251	75				65,5
U 5SLXG-600/20 T	155	1098	260	180	215	130	260	75				66,5
U 7SLG-750/12 T	155	940	220	150	180	100	260	75				68,5
U 7SLG-800/14 T	155	988	220	150	180	100	260	75				70
U 7SLG-900/16 T	155	1036	220	150	180	100	260	75	1" 1/4 G	1" 1/4 G		77
U 7SLG-950/18 T	155	1081	220	150	180	100	288	75				85,5
U 7SLG-1000/20 T	155	1128	220	150	180	100	288	75				86,5
U 7SLXG-750/12 T	155	940	260	180	215	130	260	75				68,5
U 7SLXG-800/14 T	155	988	260	180	215	130	260	75				70
U 7SLXG-900/16 T	155	1036	260	180	215	130	260	75	1" 1/4 G	1" 1/4 G		77
U 7SLXG-950/18 T	155	1081	260	180	215	130	288	75				85,5
U 7SLXG-1000/20 T	155	1128	260	180	215	130	288	75				86
U 9...-750/12 T	170	1027	260	180	215	130	280	80				72
U 9... -800/14 T	170	1088	260	180	215	130	280	80				73,5
U 9... -900/16 T	170	1147	260	180	215	130	280	80	1" 1/2 G	1" 1/2 G	81	80
U 9... -950/18 T	170	1205	260	180	215	130	308	80			89	88,5
U 9... -1000/20 T	170	1263	260	180	215	130	308	80				91



# ULTRA V-SV-L-SL-LG-SLG Serie-Mechanical seal and bearings

MECHANICAL SEAL	PUMP MODEL	SHAFT Ø		STANDARD MATERIAL	OPTIONAL
	U3-100/5, U3-120/6, U5-120/4, U5-150/5, U5-180/6, U7-180/4, U7-250/5, U7-300/6, U9-200/4, U9-250/5, U18-250/3, U18-400/4	14mm / S	<b>Rotating face</b> <b>Stationary face</b> <b>Elastomer</b>	Graphite Ceramic EPDM	SiC SiC EPDM
	U3-150/7, U3-180/8, U3-200/9, U3-250/10, U3-280/11, U3-300/12, U5-200/7, U5-250/8, U5-280/9, U5-300/10, U5-350/11, U5-380/12, U7-350/7, U7-400/8, U7-450/9, U7-550/10, U9-300/6, U9-400/7, U9-450/8, U9-500/9, U9-550/10	14mm	<b>Rotating face</b> <b>Stationary face</b> <b>Elastomer</b>	Graphite SiC EPDM	SiC SiC EPDM
	U18-450/5, U18-550/6, U18-750/8, U18-900/9, U18-920/10, U18-1000/11	14mm / L	<b>Rotating face</b> <b>Stationary face</b> <b>Elastomer</b>	Graphite SiC EPDM	SiC SiC EPDM
	U3-350/14, U3-380/16, U3-400/18, U3-450/20, U5-400/14, U5-450/16, U5-550/18, U5-600/20, U7-750/12, U7-800/14, U7-900/16, U7-950/18, U7-1000/20, U9-750/12, U9-800/14, U9-900/16, U9-950/18, U9-1000/20	14mm / Balanced seal	<b>Rotating face</b> <b>Stationary face</b> <b>Elastomer</b>	Tungsten carbide Graphite EPDM	- - -

BEARINGS	PUMP MODEL	TYPE	
	U3-100/5, U3-120/6, U5-120/4	6202-ZZ	6302-ZZ C3
	U3-150/7, U3-180/8, U3-200/9, U3-250/10, 3- U3-280/11, 3- U3-300/12, U5-150/5, U5-180/6, U5-200/7, U5-250/8, 3- U5-280/9, 3- U5-300/10, U7-180/4, U7-250/5, 3- U7-300/6, U9-200/4, U9-250/5, 3- U9-300/6, U18-250/3	6204-ZZ	6304-ZZ C3
	1- U3-280/11, 1- U3-300/12, 1- U5-280/9, 1- U5-300/10, U5-350/11, U5-380/12, 1- U7-300/6, U7-350/7, U7-400/8, 1- U9-300/6, U9-400/7, U18-400/4, U3-350/14, U3-380/16, U3-400/18, U5-400/14	6203-ZZ	6305-ZZ C3
	U7-450/9, U7-550/10, U9-450/8, U9-500/9, U9-550/10, U18-450/5, U18-550/6	6204-ZZ	6306-ZZ-C3
	U3-450/20, U5-450/16, U5-550/18, U5-600/20	6204-ZZ	3206-ZZ C3
	U7-750/12, U7-800/14, U7-900/16, U9-750/12, U9-800/14, U9-900/16, U18-750/8, U18-900/9, U18-920/10	6206-ZZ C3	3306-ZZ C3
	U7-950/18, U7-1000/20, U9-950/18, U9-1000/20, U18-1000/11	6206-ZZ C3	3308-ZZ C3



# ULTRA+VSD

Vertical booster pump with variable speed



## DESCRIPTION

Horizontal pump of ULTRA series provided with variable speed drive EPIC or IPFC. This booster pump assure the desired pressure regardless changes on flow demand making it suitable for low or missing pressure in residential systems and industrial applications. It is required the installation of a membrane tank downstream the system.

## FEATURES

- EPIC or IPFC variable speed drive
- Vertical pump of ULTRA series
- Pressure sensor wired to the vsd
- Cable with plug for EPIC vsd only

## FUNCTIONING

If the pressure in the network drops the pump will starts and gradually speeds up to provide with the set pressure. When the water demand decreases, the pressure will rise causing the pump speed to slow down and eventually to stop the pump if demand ceases. The pump will remain on standby waiting to start at the next water demand.

## SELECTION

The table below shows the vertical ULTRA pump models available for the assembly with EPIC or IPFC. Consult the catalog at the ULTRA series for pump specifics and characteristic curves.

PUMP								VSD		
TYPE	MODEL	Version						TYPE	Power system	
		V	SV	L	SL/SLX	LG	SLG/SLGX		in	out
U 3	100/5T	■	■	■	■	-	-	EPIC	1-230	3-230
		■	■	■	■	-	-	IPFC109	1-230	3-230
		■	■	■	■	-	-	IPFC306	3-400	3-400
	120/6T	■	■	■	■	-	-	EPIC	1-230	3-230
		■	■	■	■	-	-	IPFC109	1-230	3-230
		■	■	■	■	-	-	IPFC306	3-400	3-400
	150/7T	■	■	■	■	-	-	EPIC	1-230	3-230
		■	■	■	■	-	-	IPFC109	1-230	3-230
		■	■	■	■	-	-	IPFC306	3-400	3-400
	180/8T	■	■	■	■	-	-	EPIC	1-230	3-230
		■	■	■	■	-	-	IPFC109	1-230	3-230
		■	■	■	■	-	-	IPFC306	3-400	3-400
	200/9T	■	■	■	■	-	-	EPIC	1-230	3-230
		■	■	■	■	-	-	IPFC109	1-230	3-230
■		■	■	■	-	-	IPFC306	3-400	3-400	
250/10T	■	■	■	■	-	-	EPIC	1-230	3-230	
	■	■	■	■	-	-	IPFC114	1-230	3-230	
	■	■	■	■	-	-	IPFC306	3-400	3-400	
280/11T	-	■	-	■	-	-	EPIC	1-230	3-230	
	■	■	■	■	-	-	IPFC114	1-230	3-230	
	■	■	■	■	-	-	IPFC306	3-400	3-400	
300/12T	■	■	■	■	-	-	IPFC114	1-230	3-230	
	■	■	■	■	-	-	IPFC306	3-400	3-400	
350/14T	-	-	-	-	-	■	IPFC114	1-230	3-230	
	-	-	-	-	-	■	IPFC306	3-400	3-400	
380/16T	-	-	-	-	-	■	IPFC114	1-230	3-230	
	-	-	-	-	-	■	IPFC309	3-400	3-400	
400/18T	-	-	-	-	-	■	IPFC309	3-400	3-400	
450/20T	-	-	-	-	-	■	IPFC309	3-400	3-400	
U 5	120/4T	■	■	■	■	-	-	EPIC	1-230	3-230
		■	■	■	■	-	-	IPFC109	1-230	3-230
		■	■	■	■	-	-	IPFC306	3-400	3-400
	150/5T	■	■	■	■	-	-	EPIC	1-230	3-230
		■	■	■	■	-	-	IPFC109	1-230	3-230
		■	■	■	■	-	-	IPFC306	3-400	3-400
	180/6T	■	■	■	■	-	-	EPIC	1-230	3-230
		■	■	■	■	-	-	IPFC109	1-230	3-230
		■	■	■	■	-	-	IPFC306	3-400	3-400
	200/7T	■	■	■	■	-	-	EPIC	1-230	3-230
		■	■	■	■	-	-	IPFC109	1-230	3-230
		■	■	■	■	-	-	IPFC306	3-400	3-400
	250/8T	■	■	■	■	-	-	EPIC	1-230	3-230
		■	■	■	■	-	-	IPFC114	1-230	3-230
■		■	■	■	-	-	IPFC306	3-400	3-400	
280/9T	■	■	■	■	-	-	IPFC114	1-230	3-230	
	■	■	■	■	-	-	IPFC306	3-400	3-400	
300/10T	■	■	■	■	-	-	IPFC114	1-230	3-230	
	■	■	■	■	-	-	IPFC306	3-400	3-400	
350/11T	■	■	■	■	-	-	IPFC114	1-230	3-230	
	■	■	■	■	-	-	IPFC306	3-400	3-400	
380/12T	■	■	■	■	-	-	IPFC309	3-400	3-400	
400/14T	-	-	-	-	-	■	IPFC309	3-400	3-400	
450/16T	-	-	-	-	-	■	IPFC309	3-400	3-400	
550/18T	-	-	-	-	-	■	IPFC309	3-400	3-400	
600/20T	-	-	-	-	-	■	IPFC311	3-400	3-400	



# ULTRA+VSD

PUMP								VSD		
TYPE	MODEL	Version						TYPE	Power system	
		V	SV	L	SL/SLX	LG	SLG/SLGX		in	out
U 7	180/4T	■	■	■	■	-	-	EPIC	1-230	3-230
		■	■	■	■	-	-	IPFC109	1-230	3-230
		■	■	■	■	-	-	IPFC306	3-400	3-400
	250/5T	■	■	■	■	-	-	IPFC114	1-230	3-230
		■	■	■	■	-	-	IPFC306	3-400	3-400
	300/6T	■	■	■	■	-	-	IPFC114	1-230	3-230
		■	■	■	■	-	-	IPFC306	3-400	3-400
	350/7T	■	■	■	■	-	-	IPFC114	1-230	3-230
		■	■	■	■	-	-	IPFC306	3-400	3-400
	400/8T	■	■	■	■	-	-	IPFC309	3-400	3-400
	450/9T	■	■	■	■	-	-	IPFC309	3-400	3-400
	550/10T	■	■	■	■	-	-	IPFC311	3-400	3-400
	750/12T	-	-	-	-	-	■	IPFC311	3-400	3-400
800/14T	-	-	-	-	-	■	IPFC314	3-400	3-400	
900/16T	-	-	-	-	-	■	IPFC314	3-400	3-400	
950/18T	-	-	-	-	-	■	IPFC318	3-400	3-400	
1000/20T	-	-	-	-	-	■	IPFC318	3-400	3-400	
U 9	200/4T	■	■	■	■	-	-	EPIC	1-230	3-230
		■	■	■	■	-	-	IPFC109	1-230	3-230
		■	■	■	■	-	-	IPFC306	3-400	3-400
	250/5T	■	■	■	■	-	-	EPIC	1-230	3-230
		■	■	■	■	-	-	IPFC114	1-230	3-230
	300/6T	■	■	■	■	-	-	IPFC306	3-400	3-400
		■	■	■	■	-	-	IPFC114	1-230	3-230
	400/7T	■	-	■	-	-	-	IPFC306	3-400	3-400
		-	-	-	■	-	-	IPFC309	3-400	3-400
	450/8T	■	■	■	■	-	-	IPFC309	3-400	3-400
	500/9T	■	■	■	■	-	-	IPFC309	3-400	3-400
	550/10T	■	■	■	■	-	-	IPFC311	3-400	3-400
	750/12T	-	-	-	-	-	■	IPFC311	3-400	3-400
800/14T	-	-	-	-	-	■	IPFC314	3-400	3-400	
900/16T	-	-	-	-	-	■	IPFC314	3-400	3-400	
950/18T	-	-	-	-	-	■	IPFC318	3-400	3-400	
1000/20T	-	-	-	-	-	■	IPFC318	3-400	3-400	





PUMP									VSD		
TYPE	MODEL	Version							TYPE	Power system	
		V	SV	L	SL/SLX	LG	HS	HX		in	out
U 18	100/1T	-	-	-	-	-	-	■	IPFC109	1-230	3-230
		-	-	-	-	-	-	■	IPFC306	3-400	3-400
	200/2T	-	-	-	-	-	-	■	IPFC109	1-230	3-230
		-	-	-	-	-	-	■	IPFC306	3-400	3-400
	250/3T	■	■	■	■	-	-	-	EPIC	1-230	3-230
		■	■	■	■	-	-	-	IPFC114	1-230	3-230
		■	■	■	■	-	-	-	IPFC306	3-400	3-400
	300/3T	-	-	-	-	-	-	■	IPFC114	1-230	3-230
		-	-	-	-	-	-	■	IPFC306	3-400	3-400
	400/4T	■	■	■	■	-	-	■	IPFC114	1-230	3-230
		■	■	■	■	-	-	■	IPFC306	3-400	3-400
	450/5T	■	■	■	■	-	-	-	IPFC309	3-400	3-400
	550/5T	-	-	-	-	-	-	■	IPFC309	3-400	3-400
	550/6T	■	■	■	■	-	-	-	IPFC311	3-400	3-400
	750/6T	-	-	-	-	-	-	■	IPFC311	3-400	3-400
	750/7T	-	-	-	-	-	-	■	IPFC311	3-400	3-400
	750/8T	■	■	■	■	-	-	-	IPFC314	3-400	3-400
	900/9T	■	■	■	■	-	-	-	IPFC318	3-400	3-400
	920/10T	-	-	-	-	■	-	-	IPFC318	3-400	3-400
	1000/8T	-	-	-	-	-	-	■	IPFC314	3-400	3-400
	1000/9T	-	-	-	-	-	-	■	IPFC314	3-400	3-400
	1000/11T	-	-	-	-	■	-	-	IPFC318	3-400	3-400
1500/10T	-	-	-	-	-	-	■	IPFC318	3-400	3-400	
1500/11T	-	-	-	-	-	-	■	IPFC318	3-400	3-400	
1500/12T	-	-	-	-	-	-	■	IPFC325	3-400	3-400	
1500/13T	-	-	-	-	-	-	■	IPFC325	3-400	3-400	
1500/14T	-	-	-	-	-	-	■	IPFC325	3-400	3-400	
2000/15T	-	-	-	-	-	-	■	IPFC325	3-400	3-400	
2000/16T	-	-	-	-	-	-	■	IPFC325	3-400	3-400	
2000/17T	-	-	-	-	-	-	■	IPFC330	3-400	3-400	
U 22	200/1T	-	-	-	-	-	-	■	IPFC109	1-230	3-230
		-	-	-	-	-	-	■	IPFC306	3-400	3-400
	300/2T	-	-	-	-	-	-	■	IPFC114	1-230	3-230
		-	-	-	-	-	-	■	IPFC306	3-400	3-400
	400/3T	-	-	-	-	-	-	■	IPFC309	3-400	3-400
	550/4T	-	-	-	-	-	-	■	IPFC311	3-400	3-400
	750/5T	-	-	-	-	-	-	■	IPFC311	3-400	3-400
	1000/6T	-	-	-	-	-	-	■	IPFC314	3-400	3-400
	1000/7T	-	-	-	-	-	-	■	IPFC318	3-400	3-400
	1500/8T	-	-	-	-	-	-	■	IPFC318	3-400	3-400
	1500/9T	-	-	-	-	-	-	■	IPFC325	3-400	3-400
	1500/10T	-	-	-	-	-	-	■	IPFC325	3-400	3-400
	2000/11T	-	-	-	-	-	-	■	IPFC325	3-400	3-400
	2000/12T	-	-	-	-	-	-	■	IPFC325	3-400	3-400
2000/13T	-	-	-	-	-	-	■	IPFC330	3-400	3-400	
2000/14T	-	-	-	-	-	-	■	IPFC330	3-400	3-400	



# ULTRA+VSD

		PUMP							VSD		
TYPE	MODEL	Version							TYPE	Power system	
		V	SV	L	SL/SLX	LG	HS	HX		in	out
U 35	300/1T	-	-	-	-	-	■	■	IPFC114	1-230	3-230
		-	-	-	-	-	■	■	IPFC306	3-400	3-400
	550/2-2RT	-	-	-	-	-	■	■	IPFC309	3-400	3-400
	550/2-1RT	-	-	-	-	-	■	■	IPFC309	3-400	3-400
	750/2T	-	-	-	-	-	■	■	IPFC311	3-400	3-400
	750/3-2RT	-	-	-	-	-	■	■	IPFC311	3-400	3-400
	1000/3-1RT	-	-	-	-	-	■	■	IPFC314	3-400	3-400
	1000/3T	-	-	-	-	-	■	■	IPFC314	3-400	3-400
	1000/4-2RT	-	-	-	-	-	■	■	IPFC318	3-400	3-400
	1500/4-1RT	-	-	-	-	-	■	■	IPFC318	3-400	3-400
	1500/4T	-	-	-	-	-	■	■	IPFC325	3-400	3-400
	1500/5-2RT	-	-	-	-	-	■	■	IPFC325	3-400	3-400
	1500/5-1RT	-	-	-	-	-	■	■	IPFC325	3-400	3-400
	2000/5T	-	-	-	-	-	■	■	IPFC325	3-400	3-400
	2000/6-2RT	-	-	-	-	-	■	■	IPFC325	3-400	3-400
	2000/6-1RT	-	-	-	-	-	■	■	IPFC330	3-400	3-400
2000/6T	-	-	-	-	-	■	■	IPFC330	3-400	3-400	
2000/7-2RT	-	-	-	-	-	■	■	IPFC330	3-400	3-400	
2000/7-1RT	-	-	-	-	-	■	■	IPFC330	3-400	3-400	
U 50	400/1-1RT	-	-	-	-	-	■	■	IPFC114	1-230	3-230
		-	-	-	-	-	■	■	IPFC306	3-400	3-400
	550/1T	-	-	-	-	-	■	■	IPFC309	3-400	3-400
	750/2-2RT	-	-	-	-	-	■	■	IPFC311	3-400	3-400
	1000/2T	-	-	-	-	-	■	■	IPFC318	3-400	3-400
	1500/3-2RT	-	-	-	-	-	■	■	IPFC325	3-400	3-400
	1500/3T	-	-	-	-	-	■	■	IPFC318	3-400	3-400
	2000/4-2RT	-	-	-	-	-	■	■	IPFC325	3-400	3-400
2000/4T	-	-	-	-	-	■	■	IPFC330	3-400	3-400	
U 75	550/1-1RT	-	-	-	-	-	■	■	IPFC309	3-400	3-400
	750/1T	-	-	-	-	-	■	■	IPFC311	3-400	3-400
	1000/2-2RT	-	-	-	-	-	■	■	IPFC318	3-400	3-400
	1500/2-1RT	-	-	-	-	-	■	■	IPFC318	3-400	3-400
	1500/2T	-	-	-	-	-	■	■	IPFC325	3-400	3-400
	2000/3-2RT	-	-	-	-	-	■	■	IPFC325	3-400	3-400
	2000/3-1RT	-	-	-	-	-	■	■	IPFC330	3-400	3-400
U 90	750/1-1RT	-	-	-	-	-	■	■	IPFC311	3-400	3-400
	1000/1T	-	-	-	-	-	■	■	IPFC318	3-400	3-400
	1500/2-2RT	-	-	-	-	-	■	■	IPFC325	3-400	3-400
	2000/2T	-	-	-	-	-	■	■	IPFC330	3-400	3-400

